



Safety & Instruction Manual

Encore® Muzzleloader Rifle & Pistol

Including The 209x50, Encore® Pro-Hunter™
& Encore® Endeavor™ Muzzleloaders.

Rimfire & Centerfire Rifle, Pistol & Shotgun Variations
of the Encore Are Covered In Separate Manuals.
They Are Available Free Upon Request.



WARNING: Black Powder or an approved Black Powder substitute such as Pyrodex® are the only propellant powders that are safe to use in a muzzleloading firearm.



Read the instructions and warnings in this manual
CAREFULLY BEFORE
using this firearm.

SHOCK WAVE® is a Registered Trademark
of Alliant Techsystems Inc. and
is used under license

THOMPSON/CENTER ARMS
2100 Roosevelt Avenue • Springfield, MA 01104
Toll Free Phone (866) 730-1614
www.tcarms.com

Copyright © 2014 Smith & Wesson Corp.
All rights reserved.



WARNING



**READ THESE
INSTRUCTIONS AND
WARNINGS CAREFULLY.
BE SURE YOU UNDERSTAND THESE
INSTRUCTIONS AND WARNINGS
BEFORE USING THIS FIREARM.
FAILURE TO READ THESE INSTRUCTIONS
AND TO FOLLOW THESE WARNINGS
MAY RESULT IN SERIOUS INJURY
OR DEATH TO YOU AND OTHERS
AND DAMAGE TO PROPERTY**

**This SAFETY & INSTRUCTION
MANUAL should always accompany
this firearm and be transferred with it
upon change of ownership or when the
firearm is presented to another person.**

**Always keep your firearm pointed in a
safe direction. Never point a firearm at
anything you do not intend to shoot.**

**If you don't have a manual, printed
copies are available free upon request
by contacting the factory at the address
below. They are also available via
download from the company's web site
shown below.**

**THOMPSON/CENTER ARMS
• CUSTOMER SUPPORT •**

2100 Roosevelt Avenue • Springfield, MA 01104

TEL. Toll Free (866) 730-1614

www.tcarms.com

NOTE: The Encore®, as sold by Thompson/Center, is sold as either a handgun or a long gun. Changes to the configuration of the Encore by the end-user, including but not limited to, a butt stock on a pistol, or a pistol barrel (under 16 inches) on a long gun, may subject the firearm to classification under the National Firearms Act, which imposes registration, taxes, and other requirements on the owners of such firearms. It is your responsibility to comply with all Federal, state and local laws and regulations regarding the ownership or possession of a firearm such as the Encore and any conversions or additions of any aftermarket accessories to your Encore.

TABLE OF CONTENTS

YOUR SAFETY RESPONSIBILITIES	3-7
SAFE STORAGE & TRANSPORTATION	8-9
SAFETY RULES FOR ALL T/C MUZZLELOADERS	10-12
BASIC EQUIPMENT FOR SHOOTING THE ENCORE®	13
UNDERSTANDING BLACK POWDER	14
UNDERSTANDING PYRODEX®	15
ENCORE® TRIGGER & HAMMER	16
PREPARATION FOR FIRING	17
MODEL & FEATURES IDENTIFICATION	18
INSPECTING YOUR ENCORE® MUZZLELOADER	19
INSTALLING A BARREL	20-21
CHARGING THE ENCORE® MUZZLELOADER	22-27
PRIMING THE ENCORE® MUZZLELOADER	28-29
FIRING THE ENCORE® MUZZLELOADER	29-31
UNLOADING AND UNCHARGING	32-33
FIELD CLEANING	34-35
THOROUGH CLEANING	36-38
DISASSEMBLY OF THE ENCORE® FOR CLEANING	38-40
MOUNTING A SCOPE	41
SIGHT ADJUSTMENT	42
LIMITED LIFETIME WARRANTY	42-43
CONTACT & SHIPPING FOR SERVICE	44-45
ENCORE® SPEED BREECH® APPENDIX	46-49
ENCORE® SWING HAMMER® APPENDIX	50-51
ENCORE® ENDEAVOR SPEED BREECH® XT™ APPENDIX	52-55
LOAD COMPONENTS	56
SUGGESTED LOADS FOR ENCORE® MUZZLELOADER	56-65
PATENT & CONTACT INFORMATION	68

YOUR SAFETY RESPONSIBILITIES

SAFETY IS YOUR NUMBER ONE RESPONSIBILITY!!!!

At home, in the field, at the range, or anywhere, the first concern of every firearm owner should be safety. Apply the following safety rules in every situation, with any kind of firearm. If you feel uncertain about any operational aspects of your firearm, please contact Thompson/Center before proceeding with its operation.



WARNING: YOU MUST FOLLOW ALL OF THESE SAFETY RULES TO ENSURE THE SAFE USE OF YOUR FIREARM. THE FAILURE TO FOLLOW THE INSTRUCTIONS AND WARNINGS IN THIS MANUAL COULD CAUSE SERIOUS PERSONAL INJURY OR DEATH TO YOU OR OTHERS AND DAMAGE TO PROPERTY.

As a firearm owner, you accept a demanding responsibility. How seriously you take this responsibility can be the difference between life and death. There is no excuse for careless or abusive handling of your firearm. At all times handle your firearm with intense respect for its power and potential danger.

YOUR SAFETY RESPONSIBILITIES CONT'D

- **ALWAYS KEEP YOUR FIREARM POINTED IN A SAFE DIRECTION.** Never point a firearm at anyone or anything you do not intend to shoot whether or not it is loaded. This is particularly important when loading, unloading, or field stripping the gun. ALWAYS control the direction of the firearm.
- **ALWAYS TREAT EVERY FIREARM AS IF IT IS LOADED AND WILL FIRE.** Do not take anyone's word that the firearm is uncharged or unprimed – always check for yourself. Never pass your firearm to another person until the action is open and/or on safe, and you visually check that it is uncharged and unprimed. Keep your muzzleloading firearm uncharged and unprimed and safely stored when not in use.
- **NEVER PLACE YOUR FINGER INSIDE THE TRIGGER GUARD OR ON THE TRIGGER UNLESS YOU INTEND TO FIRE.** Ensure that other objects do not touch the trigger.
- **ALWAYS BE SURE OF YOUR TARGET AND WHAT IS BEYOND IT.** Always be sure of where the bullet will strike and shoot only where there is a safe back stop free of obstructions, water or other surfaces which can cause ricochets. Be sure your bullet will stop behind your target. Bullets can glance off many surfaces like rocks or the surface of water and travel in unpredictable directions with considerable velocity. Do not fire randomly into the sky.
- **NEVER CROSS OBSTACLES SUCH AS FENCES OR STREAMS WITH A CHARGED OR PRIMED MUZZLELOADING FIREARM.** Always make certain your muzzleloading firearm is unprimed before crossing a fence, climbing a tree, jumping a ditch or negotiating other obstacles.
- **SAFE FIREARM HANDLING IS YOUR PERSONAL RESPONSIBILITY AT ALL TIMES.** Firearms can be dangerous and can cause serious injury or death if they are misused or used inappropriately. Safety must be the prime consideration of any one who owns or handles firearms. Accidents are the result of violating the rules of safe firearm handling and common sense. Firearm safety training is available. Contact your firearms dealer, law enforcement agency, local sportsman's club, the NRA, etc. for availability.
- **YOU ARE RESPONSIBLE FOR THE FIREARM AT ALL TIMES.** In owning a firearm, you must undertake full-time responsibility for your firearm's safety and security. You must protect yourself and all others against injury or death from misuse of the firearm 24 hours a day.
- **FIREARM SECURITY IS YOUR RESPONSIBILITY.** You must secure firearms safely from children and/or unauthorized users. Your firearm should always be kept unloaded and locked when not in use. Never assume that the use of a lock is sufficient to safely secure your firearm. You must always evaluate your personal situation and employ the security systems that meet your needs and prevent children and unauthorized users from gaining access to your firearm.

YOUR SAFETY RESPONSIBILITIES CONT'D

- **APPROPRIATE USE FOR YOUR FIREARM MEANS USING YOUR FIREARM FOR LEGAL PURPOSES.** For example - target shooting, hunting and lawful resistance of deadly criminal force. It is your responsibility to ensure that you are in compliance with all applicable laws and ordinances regarding the use of your firearm.
- **NEVER RELY ON MECHANICAL FEATURES ALONE.** Only your safe firearm-handling habits will ensure the safe use of your firearm. This is your responsibility.
- **ALWAYS SAFELY STORE AND SECURE YOUR FIREARM.** Safe and secure storage of your firearm is one of your most important responsibilities. It is a full-time responsibility. You must always secure your firearm, ammunition, and loading components separately so that they are not accessible to children and/or other unauthorized persons.
- **NEVER KEEP AMMUNITION AND LOADING COMPONENTS IN THE SAME LOCATION AS THE FIREARM.** Store each in a separate and secure place.
- **ALWAYS WEAR EYE PROTECTION THAT IS SPECIFIED FOR USE WITH FIREARMS** every time you handle your firearm for cleaning and maintenance.
- **ALWAYS WEAR EYE AND EAR PROTECTORS THAT ARE SPECIFIED FOR USE WITH FIREARMS** every time you discharge your firearm. Make sure others in the vicinity of where you will be shooting do so as well.
- **NEVER USE ALCOHOL OR DRUGS BEFORE OR WHILE SHOOTING.** Do not use your firearm if you are on any medication which impairs, even slightly, your mental or physical ability.
- **ALWAYS HAVE ADEQUATE VENTILATION.** Discharging firearms in poorly ventilated areas, cleaning firearms, or handling ammunition and loading components may result in exposure to lead and other substances known to cause birth defects, reproductive harm, and other serious physical injury. Review the warnings and labels for all ammunition, loading components, and cleaning products carefully. Wash hands thoroughly after exposure.
- **BEFORE HANDLING ANY FIREARM, UNDERSTAND ITS OPERATION.** Not all firearms are the same. Familiarize yourself with the mechanical features of any firearm you intend to use. If you feel uncertain about any operational aspects of your firearm, please contact Thompson/Center before proceeding with its operation.
- **NEVER ALLOW A FIREARM TO BE USED BY INDIVIDUALS WHO DO NOT UNDERSTAND ITS SAFE OPERATION OR HAVE NOT READ THESE FIREARM SAFETY RULES.**

YOUR SAFETY RESPONSIBILITIES CONT'D

- **ALWAYS USE THE CORRECT COMBINATION OF LOAD COMPONENTS FOR YOUR PARTICULAR MUZZLELOADING FIREARM** as detailed in this manual.
- **BE CERTAIN THE BARREL IS CLEAR OF OBSTRUCTIONS BEFORE SHOOTING.** Mud, water, snow or other objects may inadvertently lodge in the barrel bore. A small obstruction can cause a dangerous increase in pressure and may damage your firearm and cause injury to yourself and others.
- **BE SURE ALL ACCESSORIES, SUCH AS HOLSTERS, GRIPS, SLINGS, SCOPES AND OTHER ACCESSORIES ARE COMPATIBLE** with the firearm and that the accessories do not interfere with safe operation. It is your responsibility to understand and follow all of the instructions in this manual, as well as those which may be supplied with your ammunition and loading components and any accessory.
- **NEVER DISASSEMBLE YOUR FIREARM** beyond the procedures outlined in this manual. Improper disassembly or re-assembly of your firearm may be dangerous and can lead to serious injury or death.
- **NEVER MANIPULATE, ADJUST OR CHANGE ANY OF THE INTERNAL COMPONENTS OF YOUR FIREARM UNLESS SPECIFICALLY INSTRUCTED TO DO SO IN THIS MANUAL.** Improper manipulation of any other internal component may affect the safety and reliability of your firearm and may cause serious injury or death.
- **NEVER ALLOW ANY ALTERATION OR REPLACEMENT OF PARTS IN YOUR THOMPSON/CENTER FIREARM UNLESS PERFORMED BY A QUALIFIED GUNSMITH** using genuine Thompson/Center parts. If you do otherwise, improper functioning of your firearm may occur and serious injury or death and damage to property may result.



WARNING: SAFE USE OF A FIREARM IS YOUR PERSONAL RESPONSIBILITY AND THE FAILURE TO FOLLOW ALL OF THESE BASIC SAFETY RULES MAY RESULT IN SEVERE PERSONAL INJURY OR DEATH TO YOU OR OTHERS AND DAMAGE TO PROPERTY. YOU ARE THE MOST IMPORTANT SAFETY DEVICE WHEN IT COMES TO THE USE OF YOUR FIREARM AND THOMPSON/CENTER WILL NOT BE RESPONSIBLE FOR ANY PERSONAL INJURY, DEATH OR PROPERTY DAMAGE THAT RESULTS FROM: (1) THE CRIMINAL OR NEGLIGENT USE OF THIS FIREARM; (2) A DISREGARD OF THESE SAFETY INSTRUCTIONS AND WARNINGS; (3) IMPROPER OR CARELESS HANDLING OF THIS FIREARM; (4) THE USE OF NON-STANDARD, DEFECTIVE, IMPROPER LOAD COMPONENTS, OR (5) IMPROPER OR NEGLIGENT MODIFICATIONS OR REPAIRS TO THE FIREARM.

YOUR SAFETY RESPONSIBILITIES CONT'D

- **NEVER CLIMB TO OR DESCEND FROM A TREE STAND WITH A PRIMED MUZZLELOADING FIREARM. NEVER RAISE OR LOWER A PRIMED MUZZLELOADING FIREARM TO OR FROM A TREE STAND.** Failure to follow this rule may cause serious injury and/or death to the shooter or bystanders and damage to property.
- **NEVER LEAN A CHARGED AND PRIMED RIFLE AGAINST A TREE, A WALL OR ANY SURFACE WHERE IT MAY FALL OVER.** Once the rifle has been charged it is your responsibility to guard against situations that may result in an accidental discharge. Failure to follow this rule may cause serious injury and/or death to the shooter or bystanders and damage to property.
- **USE THOMPSON/CENTER SCOPE MOUNTS ONLY.** The current product catalog lists a series of scopes and mounts which are designed specifically for use with our firearms. These mounts make use of existing screw holes. Those who desire a scope sight should make use of Thompson/Center mounts. Do not drill additional holes in the barrel as this could weaken the barrel structure leading to a rupture. A ruptured barrel can cause serious injury and/or death to the shooter or bystanders and damage to property.



WARNING: DO NOT DRILL HOLES IN THE BARREL AS THIS COULD WEAKEN THE BARREL STRUCTURE LEADING TO A RUPTURE. A RUPTURED BARREL CAN CAUSE SERIOUS INJURY AND/OR DEATH TO THE SHOOTER OR BYSTANDERS AND DAMAGE TO PROPERTY. DRILLING HOLES IN THE BARREL ALSO VOIDS ALL WARRANTIES.

- **NEVER MODIFY ANY OF THE PARTS IN YOUR FIREARM.** Do not add or replace any of the parts in your firearm unless they are genuine Thompson/Center parts and you follow the instructions supplied by Thompson/Center. If you do otherwise, improper functioning may occur and serious injury or death may result. In addition to the dangers presented, the use of non-factory parts, including but not limited to, stocks and springs, voids all warranties.



WARNING: NEVER RELY ON MECHANICAL SAFETY FEATURES OF THE FIREARM ALONE. ONLY YOUR SAFE FIREARM HANDLING WILL ENSURE THE SAFE USE OF YOUR FIREARM. THIS IS YOUR RESPONSIBILITY.

SAFE STORAGE & TRANSPORTATION



WARNING: ALWAYS POINT THE MUZZLE IN A SAFE DIRECTION.



WARNING: FIREARMS ARE DANGEROUS WHEN USED AND STORED IMPROPERLY. THEY POSE A RISK OF SERIOUS OR FATAL INJURIES. FIREARMS CAN BE ESPECIALLY DANGEROUS TO CHILDREN WHEN THEY ARE STORED IN AN IRRESPONSIBLE AND UNSAFE MANNER. FOR YOUR SAFETY AND THE SAFETY OF OTHERS, IT IS IMPERATIVE THAT YOU KEEP YOUR FIREARM LOCKED AND UNLOADED IN A SECURE PLACE. THE AMMUNITION AND LOADING COMPONENTS SHOULD BE STORED IN A SEPARATE, SECURE LOCATION WHEN IT IS NOT IN USE. SAFE AND SECURE STORAGE OF YOUR FIREARM IS ONE OF THE MOST IMPORTANT RULES OF FIREARM SAFETY. YOUR FAILURE TO FOLLOW THESE RULES MAY RESULT IN SERIOUS INJURY OR DEATH TO YOU OR OTHERS.

- **ALWAYS SECURE YOUR FIREARM IN A MANNER THAT WILL PREVENT UNAUTHORIZED ACCESS.** Whenever your firearm is not in use, keep it unloaded and locked. Your safety and the safety of others requires that you always secure and store your firearm in a manner that will prevent unauthorized access. Never leave a firearm unattended unless it is locked, unloaded and secured.



WARNING: NEVER LOCK A LOADED FIREARM AND NEVER LOAD A LOCKED FIREARM!!

- **ALWAYS STORE YOUR FIREARM AND AMMUNITION AND LOADING COMPONENTS SEPARATELY** so that they are not accessible to children or other unauthorized persons. Safe and secure storage of your firearm, ammunition, and loading components is your responsibility. It is a full-time responsibility.
- **NEVER ASSUME THAT A “HIDING” PLACE IS A SECURE STORAGE METHOD.** Others may be aware of your storage location or come upon it by chance. It is your personal responsibility to use common sense when storing your firearm and ammunition and loading components and to always make sure they are not accessible to children or other unauthorized persons.
- **NEVER TRANSPORT A CHARGED OR PRIMED MUZZLE-LOADING FIREARM.** When transporting your firearm, be sure it is uncharged, unprimed and securely locked. Safe and secure transportation of your firearm is your responsibility.

SAFE STORAGE & TRANSPORTATION CONT'D

- **ALWAYS FOLLOW THE LAW!** Many jurisdictions have laws that make it a crime to keep a firearm unlocked and in an area accessible to children or others. Keeping a firearm locked and unloaded when not in use is not only common sense safety practice... IT IS THE LAW. You must be familiar with all local, state, and federal laws regarding the safe storage and transportation of your firearm. Failure to know and follow the law may result in unauthorized access or use of your firearm by another. Obey all laws relating to the storage and transportation of firearms. Your local police department or gun shop can furnish you with available information on storing and/or transporting a firearm safely and legally.
- **YOUR FIREARM IS YOUR RESPONSIBILITY.** You must prevent your firearm from being stolen or from being used by untrained or unqualified individuals. Keep it locked, uncharged, unprimed and secured when not in use.

SAFETY RULES FOR THE ENCORE[®] MUZZLELOADER

In addition to the general Firearm Safety Responsibilities covered so far in this manual, there are additional guidelines specific to black powder muzzleloading firearms that must be adhered to at all times to ensure the safety of the shooter and others.

- **NEVER USE SMOKELESS POWDER OF ANY TYPE OR IN ANY QUANTITY IN A MUZZLELOADING FIREARM, AND NEVER MIX POWDERS.** The use of any smokeless powder could result in a detonation or explosion which could cause injury and/or death to the shooter or bystanders and damage to property.
- **USE ONLY BLACK POWDER OR AN APPROVED BLACK POWDER SUBSTITUTE SUCH AS PYRODEX[®] TO LOAD YOUR MUZZLELOADING FIREARM.** Never use even small amounts of smokeless powder, even if it is black in color. The use of any other propellant may cause injury or death to the shooter or bystanders and damage to property.
- **NEVER SMOKE WHILE USING YOUR MUZZLELOADER.** The spark from a lighted cigarette, cigar or pipe can ignite Black Powder or a Black Powder substitute such as Pyrodex, and Percussion Caps or Primers. Smoking around a charged and/or primed muzzleloader, percussion caps, primers, priming powder or supply of powder may cause premature firing of the firearm or an explosion of the powder can, horn or flask causing serious injury and/or death to the shooter or bystanders and damage to property.
- **BEFORE LOADING, MAKE SURE THE MUZZLELOADING FIREARM IS NOT ALREADY CHARGED.** To make sure it is uncharged, keep the muzzle pointed in a safe direction and insert the ramrod provided with the rifle into the bore. Note the position of the ramrod in relation to the muzzle. It will be slightly below the end of the barrel if the rifle is not loaded.
- **NEVER EXCEED THE RECOMMENDED MAXIMUM CHARGE LISTED IN THIS BOOK.** To do so could result in injury or death to the shooter or bystanders.
- **WHEN LOADING, BE CERTAIN THAT THE PROJECTILE IS LOADED IN THE PROPER SEQUENCE AND THAT IT IS SEATED FIRMLY AGAINST THE POWDER CHARGE.** Serious personal injury or death can result if the projectile is not seated properly. To provide a reference mark for future loadings, mark the ramrod at the muzzle once a projectile has been loaded to the proper depth. NOTE: Be sure to recheck the ramrod mark if you change loading components or alter the ramrod.

ENCORE® SAFETY RULES CONT'D

- **NEVER POUND ON THE RAMROD.** Black Powder and approved Black Powder substitutes such as Pyrodex® are potentially sensitive to impact and could ignite from impact. Always keep the muzzle directed away from your face or body when loading.
- **BLACK POWDER AND BLACK POWDER SUBSTITUTES SUCH AS PYRODEX® LEAVE CORROSIVE RESIDUES IN THE BORE AND ON THE FIREARM.** A thorough cleaning is absolutely necessary before storage for any amount of time to keep the firearm functioning correctly and in safe a condition.
- **UNDERSTAND THE TERMINOLOGY.** “Charge” or “Charged” applies to the presence of a propellant powder charge and projectile in the bore of the muzzleloading firearm.
- “Uncharge” or “Uncharged” refers to the opposite condition to “Charged” and indicates that the powder charge and projectile have been either fired or removed and that the bore is completely clear.
- “Prime” or “Primed” applies to the act of placing a primer, cap or priming powder in or on a muzzleloader.
- “Unprime” or “Unprimed” refers to the opposite condition of “Primed” and indicates that the primer, cap or priming powder has been removed from the firearm or is not in place.
- **NEVER PRIME YOUR MUZZLELOADING FIREARM UNTIL YOU ARE READY TO FIRE IT.** Your muzzleloader should remain unprimed until the instant before firing. After you prime the firearm, your full concentration should be on the target and the act of firing.
- **A SHARP OR HEAVY BLOW TO THE EXTERNAL HAMMER CAN FRACTURE PARTS AND CAUSE A MALFUNCTION OR DISCHARGE OF THE FIREARM.** An accidental discharge may cause serious injury and/or death to the shooter or bystanders and damage to property.
- **NEVER HAND A CHARGED MUZZLELOADING FIREARM TO ANOTHER PERSON.** Once charged, a muzzleloading firearm requires your complete attention. Never charge the firearm and then hand it to another shooter. Equally, you should never shoot a muzzleloading firearm that has been charged by someone else. Only the person doing the loading knows whether the firearm has been charged properly.

ENCORE® SAFETY RULES CONT'D

- **DO NOT CHARGE YOUR T/C MUZZLELOADER DIRECTLY FROM A CAN, HORN OR FLASK.** A spark from a previous firing may ignite the stream of powder being poured into the firearm and cause the container to explode. The explosion of a powder can, horn or flask may cause serious injury and/or death to the shooter or bystanders and damage to property. Use a separate pre-calibrated measuring device containing small quantities of powder to charge your firearm. Keep the muzzle directed away from your face and body when loading.
- **ALWAYS KEEP SUPPLIES OF POWDER, PRIMERS AND CAPS WELL AWAY FROM A FIRING POSITION OR SHOOTING BENCH.** A powder horn, flask, can of powder, or quantity of primers or caps can ignite with deadly force if exposed to sparks or intense heat. Follow the manufacturer's instructions for safe handling and storage of powder and primers or caps. Keep unused powder and primers or caps well away from firearms that are being discharged. Sparks from the discharge of a muzzle-loading firearm may cause an unused supply of powder or primers or caps to ignite causing serious injury and/or death to the shooter or bystanders and damage to property.
- You must follow this procedure every time a firearm leaves your hand, is cleaned, handed to you or another person, transported or stored.



WARNING: NEVER RELY ON MECHANICAL FEATURES ALONE. ONLY YOUR SAFE FIREARM HANDLING WILL ENSURE THE SAFE USE OF YOUR FIREARM. THIS IS YOUR RESPONSIBILITY.

BASIC EQUIPMENT FOR SHOOTING THE ENCORE®

In order to shoot your Thompson/Center Encore muzzleloader, you will need the following accessories or equipment listed below:



WARNING: DO NOT ATTEMPT TO SHOOT YOUR MUZZLELOADING FIREARM UNTIL YOU HAVE READ THIS MANUAL IN ITS ENTIRETY AND UNDERSTAND IT FULLY. FAILURE TO READ AND FOLLOW THESE INSTRUCTIONS COULD RESULT IN INJURY AND/OR DEATH TO THE SHOOTER OR BYSTANDERS AND DAMAGE TO PROPERTY. IF YOU ARE UNABLE TO UNDERSTAND ANY OR ALL OF THIS MATERIAL, CALL THE CUSTOMER SERVICE DEPARTMENT AT THOMPSON/CENTER.

1. Proper eye protection - specified for use with firearms.
2. Proper ear protection - specified for use with firearms.
3. Black Powder or an approved Black Powder substitute such as Pyrodex®, in the appropriate type for your firearm.
4. A Powder Measure.
5. Projectiles: Appropriate for your firearm.
6. 209 Primers.
7. Bore cleaning patches.
8. A Jag to hold cleaning patches.
9. An appropriate bore cleaner for muzzleloaders (like T/C's Number 13® Bore Cleaner or T17® Bore Cleaner).
10. An appropriate oil or rust inhibiting lubricant (like T/C's Natural Lube 1000 Plus™ Bore Butter).

UNDERSTANDING BLACK POWDER



Shooting muzzleloading firearms requires the shooter to be both a reloader and a rifleman at the same time. It requires strict adherence to the instructions set forth in this booklet. Failure to follow these instructions may cause damage to the firearm and injury and/or death to the shooter or bystanders and damage to property.

NOTE: Black Powder is manufactured in four specific types or granulations for use in firearms. Generally speaking, it is the granule size which determines the appropriate use of Black Powder. The largest granulations are naturally the slowest burning and, therefore, work best in large caliber rifles and shotguns. Pistols or smaller caliber rifles require a finer or faster burning powder. The priming powder used in the pan of a flint lock is extremely fine and fast burning for positive ignition of the main charge.

FG (commonly called Single “F”)

The muzzleloading enthusiast finds little use for this very coarse black powder. It's use is restricted to the large bore (10, 8, 4 gauge) shotguns of yesteryear.

FFG (commonly called Double “F”)

This is a very popular powder for .45 caliber to .58 caliber rifles. It is also used for 12, 16, and 20 gauge muzzleloading shotguns. While it is not considered a pistol powder, it is sometimes used in very large caliber single shot pistols. It is recommended for use in most T/C muzzleloaders.

FFFG (commonly called Triple “F”)

Due to its wide range of uses, Triple “F” is the black powder that is most commonly found on a dealer's shelf. It is used in all percussion revolvers, most single shot pistols, and most of the smaller (under .45 caliber) rifles. It can also be used to prime a flint lock if no 4F powder is available for that purpose.

FFFFG (commonly called Four “F”)

The finest of all currently available black powders, Four “F” is best used for priming flint locks. Due to its limited use, it is sometimes difficult to obtain.

When purchasing Black Powder be certain that it is in the original manufacturer's container and that its granulation or type is clearly marked on the label. Follow the storage and handling precautions which are on the label. If you have any questions concerning the safe handling or storage of Black Powder, write to the manufacturer of the powder. Additional information on powder storage is available from the National Fire Protection Association, P.O. Box 9146, Quincy, Mass. 02269. Or call 1-800-344-3555. Ask for pamphlet #495.

UNDERSTANDING PYRODEX®



Pyrodex® is a propellant powder designed for use in muzzleloading cap lock rifles, pistols and shotguns. Pyrodex is not Black Powder. In accordance with the manufacturer's instructions, Pyrodex relates closely to Black Powder on a volume to volume basis (not weight of charge). In other words, a black powder measure that is set to dispense 70 grains of black powder will, in fact, dispense approximately 52 grains of Pyrodex (by weight). This lighter charge of Pyrodex will provide a charge which is ballistically similar to 70 grains of Black Powder. For all practical purposes, knowing the actual weight of a charge of Pyrodex may be informative, but not necessary. Your black powder measure will dictate the proper amount by its graduations according to volume. If you want to know the actual comparative weight of a Pyrodex charge, contact the manufacturer, Hodgdon Powder Co. Inc., 6231 Robinson, Shawnee Mission, KS 66202-1332.

Pyrodex® does not ignite as easily as Black Powder and, consequently, it is not recommended for use in flint lock firearms. Flint locks require strong, positive ignition and should be charged and primed with Black Powder of the appropriate granulation only.

PYRODEX® CTG - FOR BLACK POWDER CARTRIDGES.

This powder was designed to be used in breech loading cartridge firearms (rifles, pistols & shotguns) which were intended for use with Black Powder. It has no application in Thompson/Center muzzleloading firearms. It is listed here simply for identification purposes.

PYRODEX® RS (or PYRODEX SELECT "RS") RIFLE & SHOTGUN POWDER. Designed for use in all calibers of percussion muzzleloading rifles and shotguns, this powder has a wide application. It may be used with all Thompson/Center muzzleloading rifles and shotguns. Pyrodex Select (RS) may also be used in these applications.

PYRODEX® P - PISTOL POWDER. Designed for use in most percussion muzzleloading pistols and cap and ball revolvers, this powder has application in the Thompson/Center Patriot™ Pistol.

PYRODEX® PELLETS - These pre-formed charges are designed for use in most Thompson/Center muzzleloaders and are suitable where permitted by state and local laws. Use the appropriate caliber and charge weight pellet for your muzzleloading rifle.

The reader should bear in mind that Thompson/Center does not manufacture or sell powder of any type. If there is ever a question as to the proper application of a particular powder or the safety of a given charge, write to the manufacturer of the powder. Adhere to the safe handling and storage precautions printed on the manufacturer's container and never purchase or use powders which have been removed from their original container. **USE OF THE WRONG PROPELLANT** may cause injury and/or death to the shooter or bystanders and damage to property. For information on Pyrodex write to Hodgdon Powder Co., Inc., 6430 Vista Drive, Shawnee, KS 66218.

ENCORE[®] TRIGGER & HAMMER



WARNING: THE FAILURE TO FOLLOW THESE FIREARM SAFETY REQUIREMENTS WILL CAUSE SERIOUS PERSONAL INJURY OR DEATH TO YOU OR OTHERS.

There are three hammer positions on the Encore; At Rest, Cocked and "Fired"

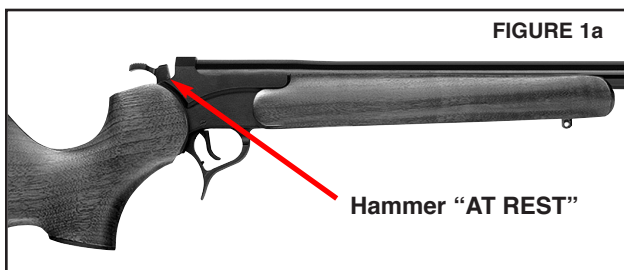

- **THE HAMMER SHOULD BE IN THE "AT REST" POSITION DURING LOADING AND WHEN CARRYING (FIGURE 1a).**

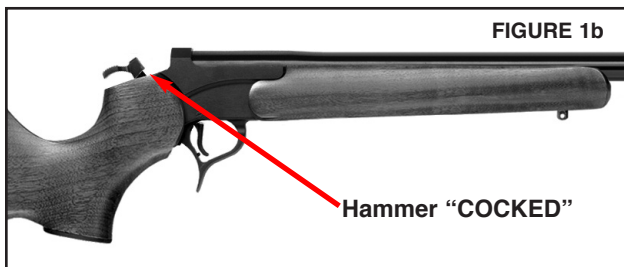

- **THE HAMMER SHOULD BE IN THE "COCKED" POSITION ONLY WHEN IN THE PROCESS OF FIRING (FIGURE 1b).**

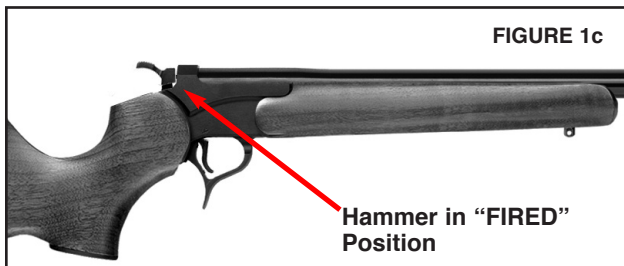

- **WHEN THE ENCORE IS COCKED AND THE TRIGGER IS PULLED - THE HAMMER CONTACTS THE FIRING PIN (FIGURE 1c).**

PREPARATION FOR FIRING



WARNING: THE FAILURE TO FOLLOW THESE FIREARM SAFETY REQUIREMENTS MAY CAUSE SERIOUS PERSONAL INJURY OR DEATH TO YOU OR OTHERS.

- **ALWAYS TREAT ALL FIREARMS AS IF THEY ARE LOADED AND WILL FIRE IF THE TRIGGER IS PULLED.**
- **ALWAYS WEAR ADEQUATE AND PROPER EAR PROTECTORS SPECIFIED FOR FIREARM USE** to prevent permanent damage to your hearing. Make sure others who are nearby are wearing ear protection as well.
- **ALWAYS WEAR PROPER CLOTHING WHEN FIRING A MUZZLELOADER.** Wearing long sleeves is recommended to protect arms from debris that may be ejected during firing.
- **ALWAYS WEAR SAFETY GLASSES SPECIFIED FOR FIREARM USE,** whether indoors or out. Safety glasses should protect your eyes from the firing flash and particles associated with the discharge of a muzzleloader. Failure to do so creates a risk of personal injury from particle or debris spitting or ricochets. Make sure others who are nearby are wearing eye protection as well.
- **ALWAYS BE ALERT AND ALWAYS FOLLOW THE SAFETY INSTRUCTIONS OF THE RANGE OFFICER.** Never shoot if you are tired, cold or impaired in any way.
- **ALWAYS BE AWARE OF OTHER PEOPLE** so that persons cannot accidentally walk into the line of fire.
- **THE SHOOTER (AND ALL OTHERS IN THE SHOOTING AREA) MUST ALWAYS BE IN A POSITION THAT IS OUT OF THE LINE OF FIRE** and are not within an area where they may be struck by ricochets or particles ejected from a firearm.
- **NEVER SHOOT AT HARD SURFACES, WATER OR RANDOMLY INTO THE SKY.** Always select a place to shoot that has a safe backstop and is free from obstructions and surfaces which cause ricochets.
- **NEVER USE ALCOHOL OR DRUGS BEFORE OR WHILE SHOOTING OR HANDLING ANY FIREARM.**
- **NEVER SMOKE WHILE SHOOTING OR HANDLING A MUZZLELOADING FIREARM.**
- **ALWAYS KEEP LOADING COMPONENTS AND LOADING RESERVES WELL AWAY FROM THE MUZZLELOADER WHEN FIRING.**

MODEL & FEATURES IDENTIFICATION

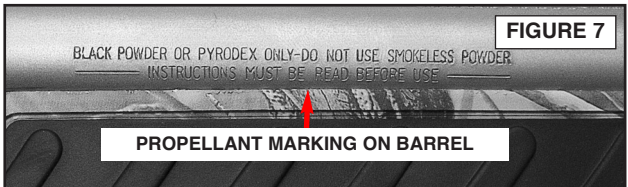
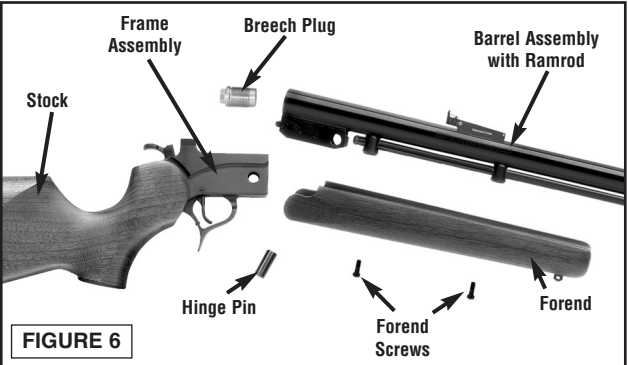
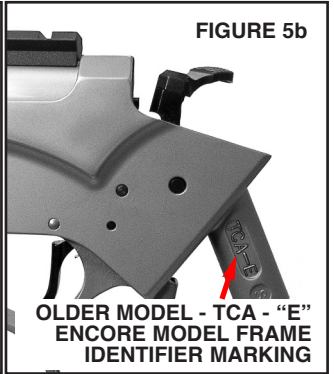
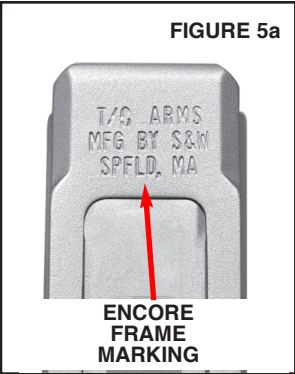
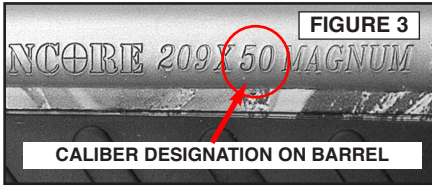

INSPECTING YOUR ENCORE[®] MUZZLELOADER



WARNING: ALWAYS KEEP THE MUZZLE POINTED IN A SAFE DIRECTION.



WARNING: ANY TIME THAT YOU HANDLE AN ENCORE FIREARM, OPEN THE ACTION AND ENSURE THAT IT IS UNCHARGED AND UNPRIMED.

INSPECTING

- With your finger away from the trigger and with the hammer in the “AT REST” position (FIGURE 8), open the action by pulling up and back on the trigger guard spur (FIGURE 9).
- Look into the barrel from the breech end to make sure there is no primer in the breech plug and no charge in the bore.
- Verify that the bore is clear and free of obstructions.
- You must follow this procedure every time a firearm leaves your hand, is cleaned, handed to you or another person, transported or stored.



WARNING: NEVER RELY ON MECHANICAL FEATURES ALONE. ONLY YOUR SAFE GUN HANDLING WILL ENSURE THE SAFE USE OF YOUR FIREARM. THIS IS YOUR RESPONSIBILITY.

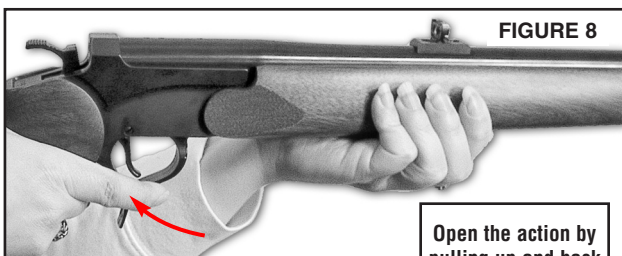

Open the action by pulling up and back on trigger guard spur - allowing the barrel to fall open.

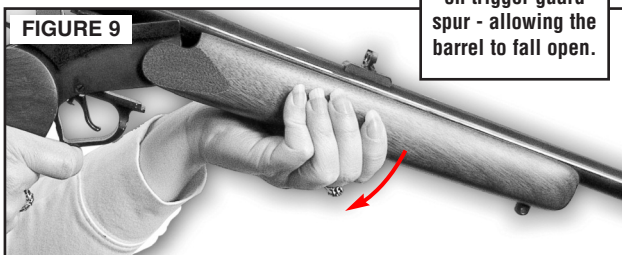

Note: Place your finger low on the trigger guard spur for maximum leverage; give it a fast, sharp pull to open the barrel.

INSTALLING A BARREL



WARNING: ALWAYS KEEP THE MUZZLE POINTED IN A SAFE DIRECTION.



WARNING: ALWAYS ENSURE THAT THE FIREARM IS UNCHARGED AND UNPRIMED WHILE INSPECTING OR ASSEMBLING.

- The forend must be removed from any barrel before it can be installed on the frame.

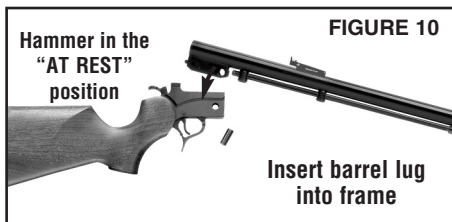

- Before assembly, apply a light film of quality gun oil to all metal parts.



- Install a barrel and corresponding forend on the frame assembly as follows:



- Insert the barrel lug into the frame (FIGURE 10).



- Align the hinge pin holes of the barrel and frame and insert the hinge pin (FIGURE 11).

- With the hinge pin centered in the frame (not protruding from either side) tip the barrel up and closed on the frame (FIGURES 12 and 13).

- Install the forend onto the barrel. Place the rear of the forend against the receiver. Align the holes in the forend over the holes in the barrel and secure the forend into place using the supplied screws (FIGURE 14).

INSTALLING A BARREL CONT'D

- With your finger away from the trigger and the hammer in the "AT REST" position, open the barrel by holding the pistol by the grip and pulling up and back on the trigger guard spur to unlock the barrel, allowing it to tip down (FIGURE 15).

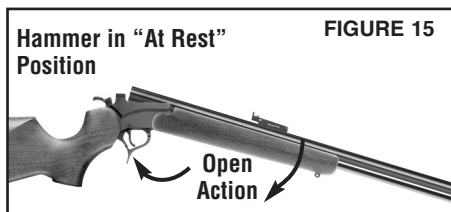
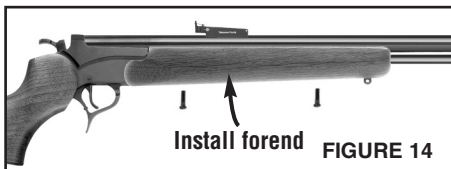

- Practice opening and closing the Encore before you attempt to load and fire it.

Note: The modular nature of the Encore design also allows easy interchange of barrels, grips and forends along with sights and scope mounts (see our catalog or web site www.tcarms.com for current options).

CHARGING THE ENCORE® MUZZLELOADER



WARNING: ALWAYS KEEP THE MUZZLE POINTED IN A SAFE DIRECTION.

“Charge” or “Charged” which applies to the presence of a propellant powder charge and projectile in the bore of the muzzle-loading firearm.

• “Uncharge” or “Uncharged” refers to the opposite condition to “Charged” and indicates that the powder charge and projectile have been either fired or removed and that the bore is completely clear.

NOTE: The loading data found in the back of this manual was compiled using Black Powder or Pyrodex® as a propellant. With any other approved Black Powder substitute, follow the instructions supplied by the manufacturer and heed all warnings and instructions as they apply to loading and usage of that product.

- Inspect the bore for obstructions and oil or grease (and clean if necessary). This is true with the rifle as it comes from the factory, as it has been treated with anti-rust compound that needs to be cleared before use.
- Do not load the muzzleloading firearm until you have read and fully understand this manual.
- Do not load the muzzleloading firearm until you are ready to use it. Keep your finger off the trigger and outside the trigger guard until you are ready to fire.

Read this manual in its entirety before attempting to load your firearm. Improper loads or loading procedure and improper use of your muzzleloading firearm may result in injury and/or death to the shooter or bystanders and damage to property.

Study the photo on page 24 carefully and read all the captions before you charge your muzzleloading rifle. The photo shows a shooter in the process of loading a Encore muzzleloader.

To open the Encore action - pull up and back on the trigger guard spur to unlock the action and allow the barrel to pivot downward. Look into the breech plug primer pocket and check to make sure there is no primer in the pocket. Hold the muzzle up to the light and look through the breech plug / ignition channel to ensure that there is no primer or powder charge present.

To close the Encore, rotate the barrel upward at the muzzle while securely holding the frame/stock assembly of the Encore stationary with one hand. Practice opening and closing the Encore before attempting to load and fire this firearm.

CHARGING THE ENCORE® CONT'D

To make sure it is unloaded, keep the muzzle pointed in a safe direction and insert the ramrod provided with the rifle into the bore. Note the position of the ramrod in relation to the muzzle. It will be slightly below the end of the barrel if the rifle is not loaded. Commit this exercise to memory and practice it every time that you handle the Encore, or any other muzzleloader. Before you attempt to load it - before you store it away - before you hand it to a friend or leave it unattended, always check to ensure that the firearm is unprimed and uncharged.

Wipe the bore free of all oil before loading. Be meticulous with your cleaning - for the presence of any amount of oil in the barrel or chamber can dampen the powder charge and cause the rifle to misfire or hangfire (see section on "Cleaning"). Point the muzzle in a safe direction and snap several 209 primers in the breech plug before charging. This will help ensure positive ignition and clear away any oil that may have accumulated in the ignition channel.

To charge the Encore with granular powder, adjust the black powder measure to dispense the desired charge and fill it with Black Powder or an approved Black Powder substitute, such as Pyrodex®.

To achieve accuracy, consistency in the powder charge is required. Fill the measure exactly the same each time.

Set the rifle on its butt and hold the muzzle away from your face and body as pictured on page 24. Pour the measured charge down the barrel and strike the side of the barrel several sharp raps with the heel of your hand. This will settle the powder into the chamber area of the barrel.

If you are using pellets - follow the instructions provided by the pellet manufacturer. Seat the projectile firmly on top of the powder or pellets. Do not pound on the ramrod or beat the projectile with excessive force, so as to crush the powder or pellet(s) and distort the bullet.

Loading Conical Lead Bullets or Sabots When Using Loose Black Powder or Granular Pyrodex®

The procedures for loading sabots or conical bullets when using loose Black Powder or loose Pyrodex® are basically the same. Care should be taken to seat the bullet or sabot firmly against the powder charge. Do not pound on it. Again, mark your ramrod at the muzzle, ensuring that each time you seat a bullet on the powder the projectile is seated to the same depth.

CHARGING THE ENCORE® CONT'D

FIGURE 16

WARNING:
IMPROPERLY CHARGING YOUR ENCORE MUZZLELOADER CAN BE DANGEROUS. STUDY THIS PHOTO CAREFULLY BEFORE PROCEEDING.

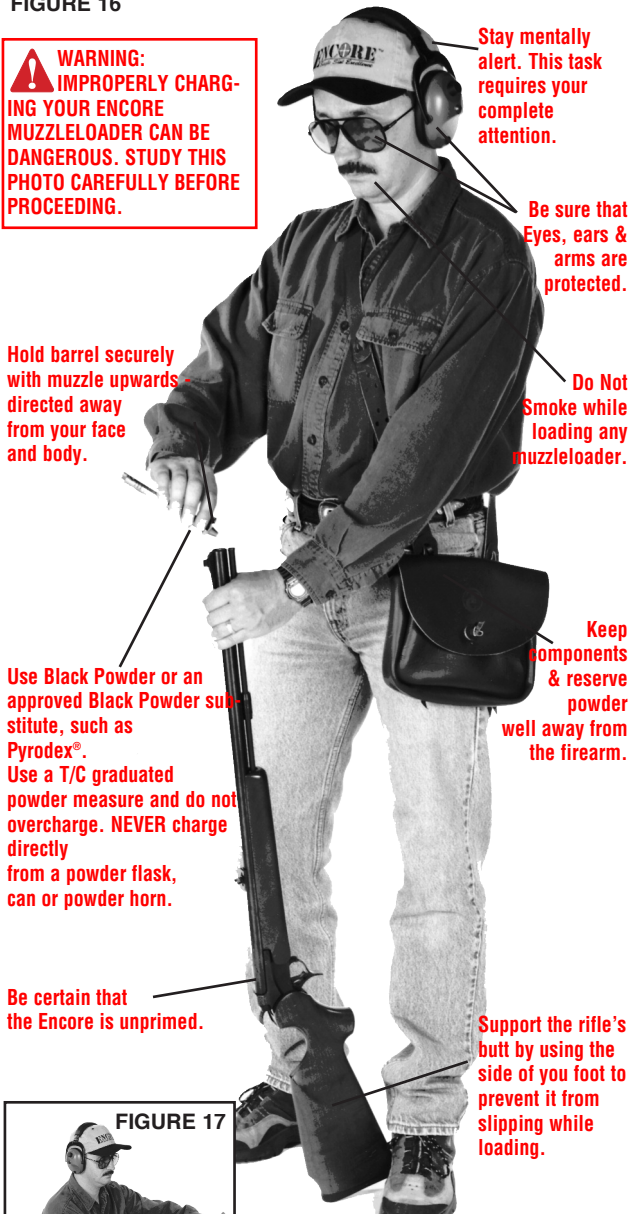

Use Black Powder or an approved Black Powder substitute, such as Pyrodex®. Use a T/C graduated powder measure and do not overcharge. NEVER charge directly from a powder flask, can or powder horn.

Be certain that the Encore is unprimed.

Stay mentally alert. This task requires your complete attention.

Be sure that Eyes, ears & arms are protected.

Do Not Smoke while loading any muzzleloader.

Keep components & reserve powder well away from the firearm.

Support the rifle's butt by using the side of you foot to prevent it from slipping while loading.

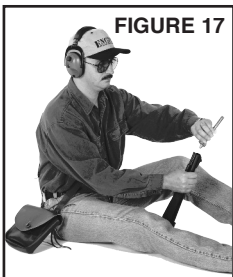

FIGURE 17

For the Encore Muzzleloading Pistol the same basic rules apply - with butt of the pistol grip resting firmly on the ground to load (FIGURE 17). With barrel held securely with muzzle upwards - directed away from your face and body.

CHARGING THE ENCORE® CONT'D

If you are loading an all-lead conical bullet like T/C's Maxi-Ball™ or Maxi-Hunter®, proceed as follows; do not use any kind of cloth patch with these projectiles. They should be lubricated prior to loading, and are designed to be shot as cast (not sized further). T/C Maxi-Ball™ and Maxi-Hunter® come from the factory pre-lubricated. However, if you encounter unlubricated bullets, we recommend that you lubricate these bullets with an all-natural lubricant, free of petroleum, like T/C Natural Lube 1000 Plus™ Bore Butter. When loading a Maxi-Ball™ or Maxi-Hunter® bullet into the muzzle, you will note how only the forward most bearing band grooves to the rifling when loading. The base of the bullet upsets (increases in diameter) upon firing, causing it to fill the grooves, thus stabilizing the projectile and aiding accuracy.



FIGURE 18

Do not lubricate sabots before loading. They are intended to be loaded into the muzzle-loader just as they come from the package. In fact, for best results, it is recommended that all evidence of oil or lubricant be removed from the bore before loading a sabot - the drier the bore the better in terms of optimal accuracy.



FIGURE 19

Hold the rifle as pictured on page 24 and pour your measured powder charge into the barrel. Start the lubricated bullet or sabot into the bore with your fingers. The base of the projectile will enter the bore easily with finger pressure. Drive the projectile down about four inches into the barrel with the rod end of the bullet starter (FIGURE 18). Using the ramrod, push the projectile the remainder of the way down the barrel until it contacts the powder charge. The sabot or conical bullet must be seated firmly against the powder charge. Seat the projectile with exactly the same pressure shot after shot to aid in accuracy.

Push the projectile down the barrel and seat it firmly against the powder charge (FIGURE 19).

CHARGING THE ENCORE® CONT'D

Once the projectile is seated firmly against the powder charge (FIGURE 20), mark your ramrod to indicate the correct loaded depth of the powder plus the projectile. This will allow you to ensure that each projectile is seated to the same depth before firing. Re-mark the ramrod each time you adjust the powder charge or change projectiles. When you arrive at the desired charge, mark the ramrod so you have a permanent reference mark (FIGURE 21). When the powder charge or projectile are then changed, the reference mark should also be changed to indicate the new correct load length.

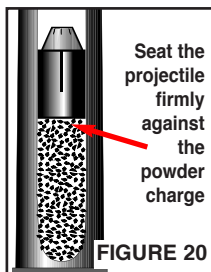

WARNING: NEVER FIRE A MUZZLELOADER UNLESS YOU ARE SURE THE PROJECTILE IS PROPERLY SEATED ON THE POWDER CHARGE AND THE RAMROD HAS BEEN REMOVED FROM THE BORE. SHOOTERS SHOULD BEAR IN MIND THAT THE MUZZLELOADING PROJECTILE IS NOT CRIMPED INTO POSITION AS IS THE FIXED CARTRIDGE PROJECTILE. IF A PROJECTILE DOES NOT FIT TIGHTLY THEN JARRING OR MOVEMENT OF THE FIREARM CAN CAUSE IT TO MOVE FORWARD IN A MUZZLELOADER. IF THE FIREARM IS FIRED WHEN A PROJECTILE IS FORWARD OR OFF THE POWDER CHARGE, OR THE RAMROD IS STILL IN THE BORE, THEN THE PROJECTILE OR RAMROD MAY ACT AS A BORE OBSTRUCTION. THIS CAN CAUSE A RUPTURED OR BURST BARREL. A RUPTURED OR BURST BARREL MAY CAUSE INJURY AND/OR DEATH TO THE SHOOTER OR BYSTANDERS AND DAMAGE TO PROPERTY. IF, DUE TO FOULING, A BULLET OR BALL BECOMES LODGED PART WAY DOWN THE BARREL, THE FIREARM MUST BE DISASSEMBLED AND THE CHARGE REMOVED. SEE SECTION ON "CLEANING". ALSO SEE SECTION ON "UNLOADING AND UNCHARGING".

Remove the ramrod from the bore and return it to the thimbles before you prime the firearm.

Loading Conical Bullets or Sabots When Using Pyrodex® Pellets

Start by loading the pellets into the bore, following the specific pellet manufacturer's instructions.

Next, start the projectile into the bore and then use your ramrod to push the projectile the remainder of the way down the bore, until it is seated firmly against the pellet(s) (FIGURE 22). Do not pound on it, as this will likely crush the pellets and effect the reliability of ignition. It could deform the bullet and affect accuracy.

CHARGING THE ENCORE® CONT'D

With successive shots, fouling may build up enough in the bore to make loading of subsequent shots more difficult, or even impossible. The more fouling that is present, the more difficult it will be to seat your projectile to the same depth. This will cause differences in pressure, which will in turn affect accuracy. While at the range, you should clean (swab) your bore (with a black powder bore cleaner like Thompson/Center's Number 13® and suitable jag/patch combination) after each shot, for maximum accuracy. In the field, you can expect to fire two to three shots before swabbing may be necessary. The more powder you use in each charge, the more fouling will build up. When you experience progressively more difficult bullet seating due to buildup of fouling, you must clean the bore or safe loading will become impossible. See the sections on "Cleaning" and on "Unloading/Uncharging".

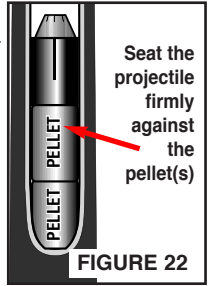

Once the sabot has been loaded, it is necessary to carefully mark your ramrod to indicate the depth of the fully seated pellet and projectile combination that you are using (FIGURE 23).

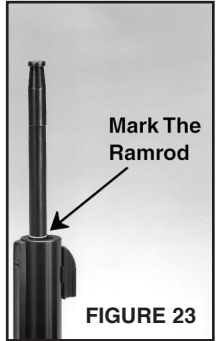

If you are loading sabots, make sure that the bore has been cleaned and that all of the oil or lubricant has been removed. The drier the bore, the better when shooting sabots, as this will improve accuracy.

NOTE: Under normal conditions the Encore® muzzleloader is unloaded simply by firing it into a suitable and safe backstop. There are, however, conditions under which the firearm cannot be fired and the charge must be removed manually:

- The projectile is not seated firmly against the powder charge, stop immediately! Do not attempt to fire the gun. You must remove the charge and then clean the barrel.
- The Encore muzzleloader is loaded in a proper manner yet fails to fire after repeated priming and clearing of the ignition fire channel.
- You are at a location that is unsuitable for discharging the firearm before transporting it.

Proceed to the section on **Unloading and Uncharging** in this manual if these conditions or any others occur where the muzzleloader cannot be discharged safely.

PRIMING THE ENCORE® MUZZLELOADER

“Prime” or “Primed” in the context of this manual refers to the act of placing a primer in the breech plug of an Encore muzzleloader.

“Unprime” or “Unprimed” refers to the opposite condition of “Primed” and indicates that the primer has been removed from the Encore muzzleloader’s breech plug or is not in place.

Use a #209 primer for ignition in all Encore muzzleloaders.



WARNING: ALWAYS POINT THE MUZZLE IN A SAFE DIRECTION.



WARNING: DO NOT PRIME THE FIREARM UNTIL YOU ARE ACTUALLY READY TO FIRE AND YOU HAVE DOUBLE CHECKED TO ENSURE THAT THE RAMROD HAS BEEN REMOVED FROM THE BORE. THOMPSON/CENTER DOES NOT RECOMMEND PRIMING THE FIREARM UNTIL THE INSTANT BEFORE FIRING. CARRYING A CHARGED, PRIMED ENCORE CAN BE DANGEROUS. ACCIDENTAL DISCHARGE IS A CONSTANT HAZARD WHICH, IF IT OCCURS, CAN CAUSE INJURY AND/OR DEATH TO THE SHOOTER OR BYSTANDERS AND DAMAGE TO PROPERTY. THE ONLY SAFE WAY TO GUARD AGAINST AN ACCIDENTAL DISCHARGE IS TO CARRY YOUR ENCORE UNPRIMED, WITH THE HAMMER IN THE "AT REST" POSITION AND THE MUZZLE POINTED DOWNRANGE AWAY FROM YOURSELF, BYSTANDERS OR PROPERTY.

After following the instructions to this point, your firearm is charged with Black Powder or an approved Black Powder substitute such as Pyrodex. A projectile is firmly seated against the powder charge. The ramrod has been returned to the thimbles under the barrel. The ramrod will be marked to the exact seating depth of the powder/projectile combination that you are using - allowing you to ensure that each future projectile is also seated to the same depth in the bore.

With the muzzle pointed in a safe direction, open the action by pulling up and back on the trigger guard spur then tipping the barrel down and open.

PRIMING THE ENCORE® CONT'D

WHEN YOU ARE READY TO FIRE YOUR ENCORE®, OPEN THE BARREL AND PRIME IT AS SHOWN HERE (FIGURE 24).



Handling 209 primers can be made easier with the (FIGURE 25) primer/deprimer tool (T/C part #7760) that is sold as an accessory. Slide a 209 primer into the slot of the tool as shown in the diagram below. To prime the gun, place the protruding part of the primer into the hole in the breech plug. Once the primer has been inserted, pull the tool away from the gun while leaving the 209 primer in the breech plug's primer pocket. To remove a 209 primer from the breech plug, push this forked end under the rim of the primer. As you push the tool forward, the primer will lift out of its hole allowing you to grasp the primer with your fingers and remove it from the gun.



If you decide not to fire; be sure to keep the gun pointed in a safe direction and remove the 209 primer from the breech plug.

FIRING THE ENCORE® MUZZLELOADER



WARNING: ALWAYS KEEP THE MUZZLE POINTED IN A SAFE DIRECTION.



WARNING: WEAR EYE AND EAR PROTECTION SPECIFIED FOR FIREARM USE EVERY TIME YOU DISCHARGE YOUR FIREARM. MAKE SURE OTHERS IN THE VICINITY OF WHERE YOU WILL BE SHOOTING DO SO AS WELL.

FIRING THE ENCORE® CONT'D

WARNING: ALWAYS HAVE ADEQUATE VENTILATION. CLEANING FIREARMS IN POORLY VENTILATED AREAS, DISCHARGING FIREARMS, OR HANDLING AMMUNITION AND LOADING COMPONENTS MAY RESULT IN EXPOSURE TO LEAD AND OTHER SUBSTANCES KNOWN TO CAUSE BIRTH DEFECTS, REPRODUCTIVE HARM AND OTHER SERIOUS PHYSICAL INJURY. WASH HANDS THOROUGHLY AFTER EXPOSURE.

WARNING: NEVER RELY ON MECHANICAL FEATURES ALONE. ONLY YOUR SAFE GUN HANDLING WILL ENSURE THE SAFE USE OF YOUR FIREARM. THIS IS YOUR RESPONSIBILITY.

WARNING: WHEN FIRING THE ENCORE, HOLD IT FIRMLY, ALLOWING YOUR BODY WEIGHT TO ABSORB AND BUFFER THE FORCE OF THE RECOIL. AN IMPROPERLY HELD FIREARM CAN CAUSE POSSIBLE INJURY AND/OR BRUISING.

Do not prime your Encore muzzleloader until you are ready to fire.

- Grasp firearm firmly with the trigger finger resting along and outside of the trigger guard (FIGURE 26).
- Raise firearm and pull the stock firmly into the shoulder or grip the pistol firmly (FIGURE 26).
- Draw the hammer back to the full rearward "COCKED" position (FIGURE 27).
- The gun will now fire when pressure is applied to the trigger.
- Place your finger on trigger and squeeze until the gun fires.

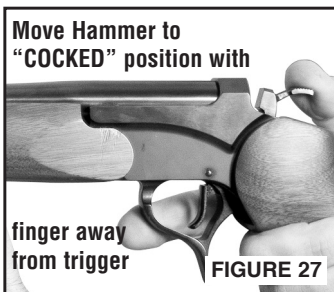

- To reload, see the **Section on "CHARGING"**.

WARNING: IF THE FIREARM IS NO LONGER GOING TO BE USED, UNCHARGE IT BY FIRING IT INTO A SUITABLE BACKSTOP OR PULL THE CHARGE BEFORE RETURNING IT TO YOUR VEHICLE, CAMP OR HOME (SEE SECTION ON "UNLOADING"). AN ACCIDENTAL DISCHARGE CAN CAUSE INJURY AND/OR DEATH TO THE SHOOTER OR BYSTANDERS AND DAMAGE TO PROPERTY.

FIRING THE ENCORE® CONT'D

- If you decide not to fire; make sure the firearm is always pointed in a safe direction - then you must carefully lower the hammer from the "Cocked" position to the "At Rest" position. To do this, place the thumb of your free hand between the hammer and the frame to prevent the hammer from moving fully forward until your finger is off the trigger and out of the trigger guard (FIG. 28).
- Place the thumb of your firing hand on the hammer spur. You must always control the hammer with your thumbs when decocking the firearm. If the hammer slips while the trigger is held to the rear and you have failed to block the hammer travel, your firearm will fire (FIGURE 29).
- Apply pressure to the trigger to release the hammer as shown (FIGURE 29). Immediately after the hammer has come out of the cocked position, release the trigger and withdraw your finger from the trigger guard (FIG. 30).
- Carefully ease the hammer forward while removing your other thumb from between the hammer and the frame (FIGURE 31) until the hammer is in the "At Rest" position (FIGURE 32).
- Open the barrel and remove the primer from the breech plug of the Encore® muzzleloader).



FIGURE 28



FIGURE 29



FIGURE 30

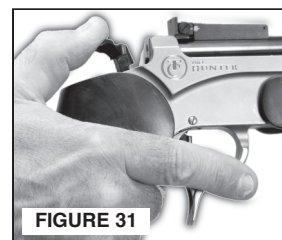



FIGURE 31



FIGURE 32

WARNING: IF YOUR FIREARM GIVES ANY INDICATION THAT IT IS NOT PERFORMING PROPERLY OR THE OPERATION OF YOUR FIREARM HAS CHANGED "THE WAY IT FEELS OR SOUNDS", STOP FIRING. MAKE SURE THE FIREARM IS POINTED IN A SAFE DIRECTION, UNLOAD THE FIREARM AND HAVE IT INSPECTED BY A FACTORY TECHNICIAN. CALL THOMPSON/CENTER CUSTOMER SERVICE.

FIRING THE ENCORE® CONT'D

 **WARNING: WHEN FIRING THE ENCORE, HOLD IT FIRMLY, ALLOWING YOUR BODY WEIGHT TO ABSORB AND BUFFER THE FORCE OF THE RECOIL. AN IMPROPERLY HELD FIREARM CAN CAUSE INJURY AND/OR BRUISING.**

Note: Use “Snap Caps” of the appropriate cartridge designation when “dry-firing” the Encore to avoid damage to the firing pin.

UNLOADING AND UNCHARGING

 **WARNING: ALWAYS KEEP THE MUZZLE POINTED IN A SAFE DIRECTION.**

 **WARNING: NEVER ATTEMPT TO PULL A CHARGE FROM YOUR MUZZLELOADER UNTIL YOU ARE ABSOLUTELY CERTAIN THAT THE FIREARM IS UNPRIMED. WHILE IN THE PROCESS OF PULLING THE CHARGE, DO NOT SMOKE, OR BE NEAR ANYONE ELSE WHO IS SMOKING; THE SPARK FROM A LIGHTED CIGARETTE, CIGAR, OR PIPE CAN IGNITE BLACK POWDER, PYRODEX, OR PRIMERS. ANY EXTERNAL HEAT SOURCE CAN IGNITE YOUR CHARGE, CAUSING AN EXPLOSION, WHICH COULD RESULT IN INJURY AND/OR DEATH TO THE SHOOTER OR BYSTANDERS AND DAMAGE TO PROPERTY.**

UNLOADING A CHARGE FROM THE ENCORE MUZZLELOADER

Under normal conditions the Encore muzzleloader is unloaded simply by firing it into a suitable and safe backstop. There are, however, some conditions under which the firearm cannot be fired and the charge must be removed manually.

THE CONDITIONS THAT REQUIRE A CHARGE TO BE REMOVED MANUALLY FROM THE BARREL OF THE ENCORE MUZZLELOADER ARE AS FOLLOWS:

- The projectile is not seated firmly against the powder charge, stop immediately! Do not attempt to fire the gun. You must remove the charge and then clean the barrel.
- If the Encore muzzleloader is loaded in a proper manner yet fails to fire after repeated priming and clearing of the ignition channel.
- If you are at a location that is unsuitable for discharging the firearm before transporting it.

To remove a charge from your Encore muzzleloader it will be necessary to take the following steps:

UNLOADING & UNCHARGING CONT'D

Tip the barrel open and make sure that the gun is unprimed.

Remove the breech plug.

With the breech plug removed, point the muzzle up. Gravity should then cause the pellets or the loose powder to drop out. The sabot or bullet can then be poked out of the bore with your ramrod. To push the bullet fully out of the barrel, it will be necessary to add the extended super jag (which came with your rifle) to your ramrod, or, you can use a longer "range rod" if you have access to one.

If your propellant (pellets or loose powder) does not come out as a result of gravity, push the entire charge out from the muzzle end with your ramrod and the installed ramrod extension. If that isn't possible, you should then pour water into the breech area of the barrel to fully saturate (and liquify) the pellets or powder. After the powder is removed, push the bullet out with your ramrod inserted from the muzzle (with the ramrod extension installed if necessary).

If you can't remove the breech plug at this point;

If you can't remove the breech plug in order to unload the charge, it will be necessary to submerge the breech section of the barrel in a pail or bucket of water.

Disassembly of the Encore will be necessary.

Check to make sure the gun is unprimed by tipping the barrel open and removing the primer from the breech plug.

Detach the barrel from the receiver assembly as detailed in the **Disassembly Section** of this manual.

Once the barrel is detached - submerge the breech section of the barrel in a pail of water (hot water if possible). Make certain that at least 8" of the breech section is submerged for at least one half hour.

After soaking the powder 1/2 hour and rendering it inert, try pulling the projectile from the bore by using your ramrod (or a range rod) with a bullet puller. Screw the bullet puller onto your rod, insert the ramrod from the muzzle end, and when you make contact with the projectile, turn the rod clockwise, screwing the bullet puller into the projectile. Once screwed into the projectile, pull the projectile out of the barrel. If you are using a sabot, make sure that both the projectile and the sabot are removed from the bore.

If, for any reason, you are unable to remove the charge in the manner recommended, squirt oil into the primer pocket of the breech plug and into the barrel's breech area in order to ensure that the powder charge is inert, (if you were to use water only - it will just dry out over a period of time), and return the barrel to the service department at the address shown below with a letter describing the problem.

THOMPSON/CENTER ARMS - Customer Support
2100 Roosevelt Avenue, Springfield, MA 01104
Toll Free Phone (866) 730-1614

FIELD CLEANING



WARNING: ALWAYS KEEP THE MUZZLE POINTED IN A SAFE DIRECTION.



WARNING: NEVER ATTEMPT TO CLEAN A CHARGED OR PRIMED MUZZLELOADING FIREARM. AN ACCIDENTAL DISCHARGE CAN CAUSE INJURY AND/OR DEATH TO THE SHOOTER OR BYSTANDERS AND DAMAGE TO PROPERTY.



WARNING: ALWAYS HAVE ADEQUATE VENTILATION. CLEANING FIREARMS IN POORLY VENTILATED AREAS, DISCHARGING FIREARMS, OR HANDLING AMMUNITION AND LOADING COMPONENTS MAY RESULT IN EXPOSURE TO LEAD AND OTHER SUBSTANCES KNOWN TO CAUSE BIRTH DEFECTS, REPRODUCTIVE HARM AND OTHER SERIOUS PHYSICAL INJURY. WASH HANDS THOROUGHLY AFTER EXPOSURE.

NOTE: Residue from burned black powder and black powder substitutes is very corrosive. The fouling or residue left over after firing your muzzleloading firearm can be destructive to the gun's parts. Leaving your firearm uncleaned with this fouling present can lead to a ruined firearm, as the gun's parts will rust and oxidize quickly.

The build-up of fouling from shot to shot will produce shot to shot increases in pressure that will greatly affect accuracy. The bullet lubricant used, the amount of powder in the charge, and the projectile used (sabot or all-lead conical bullet) will all affect the amount of fouling you will produce with each shot. Eventually, if not cleaned, the muzzleloading firearm will become impossible to load properly. Driven part way down the bore and blocked by fouling, a projectile may "hang up" and refuse to budge further.



WARNING: A PROJECTILE WHICH IS SEATED ONLY PART WAY DOWN THE BARREL SETS UP A HIGHLY DANGEROUS CONDITION WHICH MAY CAUSE A BURST BARREL AND INJURY AND/OR DEATH TO THE SHOOTER OR BYSTANDER AND DAMAGE TO PROPERTY. THE PROJECTILE MUST BE SEATED FIRMLY AGAINST THE POWDER CHARGE. IF THE PROJECTILE IS NOT SEATED AGAINST THE POWDER CHARGE THE FIREARM MUST BE DISASSEMBLED AND THE CHARGE REMOVED (SEE SECTION ON "PULLING A CHARGE"). NEVER FIRE A MUZZLELOADING FIREARM UNLESS THE PROJECTILE IS FIRMLY SEATED ON THE POWDER CHARGE.

FIELD CLEANING CONT'D

The Thompson/Center Encore® muzzleloader was supplied with a cleaning jag which is the proper size for cleaning the firearm. Use commercial cleaning patches (round or square) or pieces of cotton clothing to clean the bore.

Use the cleaning jag that was provided with the Encore, and a cleaning patch saturated with a bore cleaner like Thompson/Center's Number 13® Bore Cleaner or T-17® Bore Cleaner (FIGURE 33).

Run the saturated patch up and down the bore a few times - to remove the fouling (FIGURE 34).

Use T/C's Number 13® Bore cleaner for cleaning Black Powder or Pyrodex® fouling from muzzleloading firearms. It was specifically designed for this purpose.

After removing all the fouling, follow up with a few dry patches to thoroughly dry the bore.

Clean the frame assembly with a soft bristle brush dampened with some bore cleaner. When the frame is dry, lightly oil it. Reassemble and check for proper function of the hammer and trigger assembly.

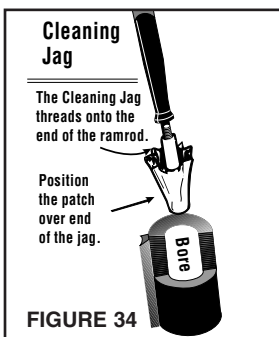

THOROUGH CLEANING



WARNING: ALWAYS KEEP THE MUZZLE POINTED IN A SAFE DIRECTION.



WARNING: NEVER ATTEMPT TO CLEAN A CHARGED OR PRIMED MUZZLELOADING FIREARM. AN ACCIDENTAL DISCHARGE CAN CAUSE INJURY AND/OR DEATH TO THE SHOOTER OR BYSTANDERS AND DAMAGE TO PROPERTY.



WARNING: WEAR SAFETY GLASSES EVERY TIME YOU ASSEMBLE OR DISASSEMBLE YOUR FIREARM.



WARNING: DO NOT ALTER, MODIFY OR REPLACE ANY OF THE PARTS OF YOUR FIREARM UNLESS THIS WORK IS PERFORMED BY A QUALIFIED GUNSMITH USING GENUINE THOMPSON/CENTER PARTS. IF YOU DO OTHERWISE, IMPROPER FUNCTIONING MAY OCCUR AND SERIOUS INJURY MAY RESULT.



WARNING: ALWAYS HAVE ADEQUATE VENTILATION. CLEANING FIREARMS IN POORLY VENTILATED AREAS, DISCHARGING FIREARMS, OR HANDLING AMMUNITION AND LOADING COMPONENTS MAY RESULT IN EXPOSURE TO LEAD AND OTHER SUBSTANCES KNOWN TO CAUSE BIRTH DEFECTS, REPRODUCTIVE HARM AND OTHER SERIOUS PHYSICAL INJURY. WASH HANDS THOROUGHLY AFTER EXPOSURE.

Proper cleaning is essential to ensure the proper functioning of your firearm.

Your firearm is a precision instrument. To ensure reliable function it is necessary to follow a routine maintenance procedure. When you are finished shooting for the day or for the season and plan to store the Encore muzzleloader away, it is recommended that you clean the firearm thoroughly.

Follow these instructions for thorough cleaning:

Tip the barrel open and be certain that there is no primer in the primer pocket.

Remove the breech plug. The breech plug of an Encore 209x50 is removed from the barrel by turning it counter-clockwise (as viewed from the breech end of the barrel) using the wrench that was supplied with the gun. For the Encore[®] Pro-Hunter and Endeavor - see the appropriate Appendix in this manual for breech plug removal instructions.

THOROUGH CLEANING CONT'D

Once removed, the breech plug should be scrubbed free of fouling and should then be lubricated with an anti-seize lubricant like T/C's Super Lube, before reinstallation. The threads inside the breech end of the barrel must also be well cleaned with a stiff brush and solvent and then dried and lubricated with anti-seize lube.

Next in the cleaning process; fill a pan with hot soapy water. Submerge the muzzle end of the barrel in the water and push a wet patch down the barrel (from the breech end) on the end of your ramrod that has a jag installed on it (a jag comes with T/C muzzleloaders from the factory). Pump the ramrod and patch up and down in the barrel. This will draw water into the barrel and flush out the fouling. When the barrel is clean, wipe off any excess water and allow it to dry.

Thoroughly wipe any powder residue from the frame assembly. Dry the parts thoroughly and lubricate them lightly to prevent rust and corrosion.

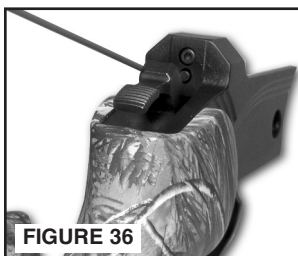
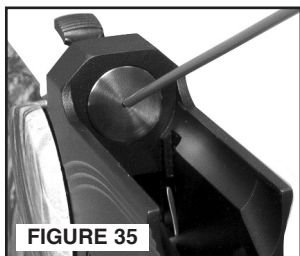

Use a pressurized moisture displacing oil to clean and lubricate the firing pin within the frame (from both the front and back - as shown in FIGURES 35 and 36).

After cleaning your Encore, it is recommended that you lightly lubricate the metal surfaces of the rifle. Do not use heavy grease or oil, as during cold weather, lube may congeal and slow the hammer fall (or keep it from striking the firing pin altogether) when the trigger is pulled.

With the barrel completely dry, lightly lubricate the bore with a quality gun lubricant or, in keeping with the all-natural method, T/C's Natural Lube 1000 Plus Bore Butter. Re-install the breech plug, making sure that you have lubricated all of the threads with an anti-seize lubricant like T/C's Super Lube. The breech plug should be threaded into place by turning it clockwise with the breech plug wrench - until it is seated. Screw breech plug in carefully. Be certain that the threads mesh properly (not cross-threaded) and ensure that the breech plug is snug.

 **WARNING: IMPROPER TYPE OR INSTALLATION OF BREECH PLUGS CAN CAUSE INJURY AND/OR DEATH TO THE SHOOTER OR BYSTANDERS AND DAMAGE TO PROPERTY.**

THOROUGH CLEANING CONT'D

Also, lubricate the threads inside the breech area of the barrel with anti-seize lubricant.

After your Encore muzzleloader breech plug has been reinstalled, check for proper functioning of the barrel and the hammer/trigger mechanism prior to loading and firing.

If the Encore muzzleloader has become very dirty due to extensive firing, the shooter may want to disassemble the rifle further than just removing the breech plug. If this happens, follow the instructions in the **Disassembly Section** that follows.

CAUTION:

Always follow the instructions provided with your gun cleaner and gun lubricant.

CAUTION:

Some cleaners can cause damage to your firearms. You should avoid prolonged solvent immersion and prolonged ultrasonic cleaning of your firearm. Choice of solvent should be restricted to those products specifically developed for firearms maintenance. Damage to a firearm's finish may occur if these cautions are ignored. Ammoniated solvents or other strong alkaline solvents, should not be used on any Thompson/Center firearm.

DISASSEMBLY OF THE ENCORE® FOR CLEANING



WARNING: ALWAYS KEEP THE MUZZLE POINTED IN A SAFE DIRECTION.



WARNING: ALWAYS MAKE SURE THAT THE MUZZLE-LOADER IS UNCHARGED AND UNPRIMED BEFORE DISASSEMBLING IT. TO ENSURE THAT THE GUN IS UNCHARGED AND UNPRIMED, TIP THE BARREL OPEN (DOWN). THIS WILL EXPOSE THE BREECH PLUG. MAKE SURE THERE IS NO PRIMER SEATED IN THE BREECH PLUG. NEXT, HOLDING THE MUZZLE UP TO THE LIGHT, LOOK THROUGH THE IGNITION FIRE CHANNEL FROM THE BREECH END TO MAKE SURE YOU CAN SEE THROUGH IT. IF YOU CANNOT SEE THROUGH IT, EITHER THE GUN IS CHARGED OR THE IGNITION FIRE CHANNEL IS OBSTRUCTED AND IT WILL BE NECESSARY FOR YOU TO REMOVE THE BREECH PLUG. IF YOU CAN SEE LIGHT, PROCEED AS FOLLOWS:

ENCORE® MUZZLELOADER DISASSEMBLY CONT'D

The Encore® Muzzleloader breaks down into three basic groups of parts as shown below:

The Frame Assembly - This assembly is held on the stock by a stock draw bolt. The fire control mechanism (hammer, sear, firing pin, etc.) is housed within the frame.

The Muzzleloading Barrel Assembly - This includes the barrel, breech plug, ramrod, thimbles and sights. It is held to the receiver by a hinge pin which anchors the barrel to the frame.

The Stock (or Grip) Assembly - Includes the stock, pistol grip, grip cap and the forend.

CAUTION: The stock bolt on your Encore® should not be over-tightened. If you apply too much force to your stock bolt during re-assembly, you may compress the stock material and induce cracking in the stock grip area. Such cracking can lead to a premature failure of the stock. The stock bolt must be torqued to 50 inch-pounds (plus or minus 5 inch-pounds).

Always use the stock bolt and washer provided with your Encore®. Use of non-factory stock bolts or stock bolts without washers can lead to stock failures.



WARNING: IF, AT ANY TIME DURING DISASSEMBLY OR REASSEMBLY OF YOUR ENCORE® YOU NOTICE CRACKING IN THE STOCK AT OR NEAR THE STOCK ATTACHMENT BOLT, DISCONTINUE USE OF YOUR STOCK AND RETURN IT TO SMITH & WESSON FOR INSPECTION.

Note: Federal law prohibits the use of a butt stock on a firearm that has a barrel less than sixteen (16) inches in length.



WARNING: NEVER DISASSEMBLE YOUR FIREARM BEYOND THE PROCEDURES OUTLINED IN THIS MANUAL. IMPROPER DISASSEMBLY OR RE-ASSEMBLY OF YOUR FIREARM MAY BE DANGEROUS AND CAN LEAD TO SERIOUS INJURY OR DEATH.

TAKEDOWN OF THE ENCORE MUZZLELOADER

- Make sure that the gun is unprimed and uncharged.
- Remove the ramrod from the thimble(s).
- Remove the forend screw(s). Turn these screws out counter-clockwise (as viewed from the bottom of the gun). Remove the forend from the barrel.
- Tip the barrel open and remove the barrel hinge pin by tapping it out (in either direction). Remove the barrel from the frame.

ENCORE® MUZZLELOADER DISASSEMBLY CONT'D

- Remove the screw that retains the extractor in the barrel lug. Then, remove the extractor from its slot.
- Use the wrench that was supplied with the Encore 209x50 muzzleloader (barrel) to remove the breech plug by turning it counter-clockwise (as viewed from the breech end of the barrel). For the Encore Pro-Hunter and Encore Endeavor - see the appropriate Appendix in this manual for breech plug removal instructions.

If you need to hold the barrel more firmly than you can with just your hand, a crescent wrench or vise on the barrel lug will supply the needed holding power. This procedure will give you the necessary leverage to “break” the gas seal which was formed when the breech plug was originally “snugged” to the barrel during installation. There will be initial resistance between these parts which must be overcome.

- Reverse these steps to reassemble, making sure that you check for proper functioning of the trigger, striker & safety mechanism prior to loading and firing. The breech plug of the Encore muzzleloader should be seated in the barrel until it is “snug”. “Snug” is defined as being as tight as you can turn it into the barrel by using the breech plug wrench and turning it clockwise, while holding the barrel in your hand. When you can no longer grip the barrel, and it turns in your hand, the breech plug is “snug”.

The breech plug should be threaded into place by turning it clockwise with the breech plug wrench - until it is fully seated. Screw the breech plug in carefully. Be certain that the threads mesh properly (not cross-threaded) and ensure that the breech plug is snug.

This diagram shows the extent to which the Encore should be disassembled (FIGURE 37).

If other service is required, contact the Thompson/Center Customer Service Department (866-730-1614).

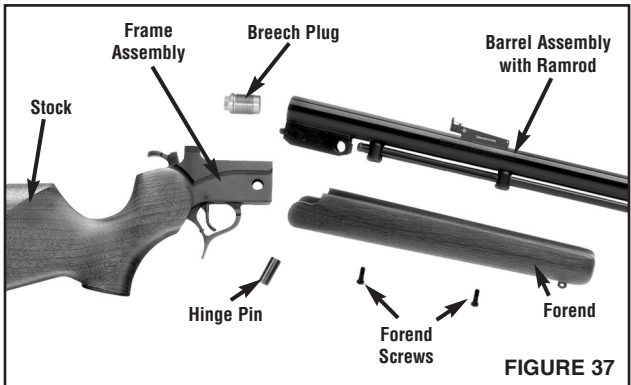

MOUNTING A SCOPE

We recommend that you have a competent gunsmith install your scope and mount.

! WARNING: ALWAYS ENSURE THAT THE FIREARM IS UNCHARGED AND UNPRIMED BEFORE INSTALLING A SCOPE OR ANY ACCESSORIES. FAILURE TO DO THIS CAN CAUSE PERSONAL INJURY OR DEATH TO YOU OR OTHERS.

! WARNING: DO NOT DRILL ADDITIONAL HOLES IN THE BARREL AS THIS COULD WEAKEN ITS STRUCTURE AND CONTRIBUTE TO A RUPTURE CAUSING INJURY AND/OR DEATH TO THE SHOOTER OR BYSTANDERS AND DAMAGE TO PROPERTY.

! WARNING: FIRING A SCOPED FIREARM WITH YOUR EYE TOO CLOSE TO THE SCOPE EYE PIECE, OR FAILING TO HOLD THE FIREARM SECURELY AGAINST RECOIL, MAY RESULT IN SERIOUS PERSONAL INJURY INCLUDING, BUT NOT LIMITED TO, BLINDNESS.

! WARNING: A SCOPE WHICH IS NOT SECURELY MOUNTED MAY BECOME DETACHED UPON RECOIL OF THE FIREARM. IF IT BECOMES DETACHED IT MAY FLY BACK AND STRIKE THE SHOOTER OR A BYSTANDER AND CAUSE INJURY. OBSERVE THE CONDITION OF ALL THE SCOPE MOUNT SCREWS AFTER FIRING. IF THE MOUNTING SCREWS SHOW SIGNS OF LOOSENING DO NOT FIRE THE FIREARM AGAIN; TAKE IT TO A QUALIFIED GUNSMITH FOR ASSISTANCE.

Follow the instructions supplied with the scope and rings to ensure proper eye relief



FIGURE 38

The barrel is factory drilled and tapped for T/C mounts. Follow the instructions that come with your scope and the mounts for proper installation. Address questions to the T/C Service Department at 866-730-1614.

SIGHT ADJUSTMENT



WARNING: ALWAYS POINT THE MUZZLE IN A SAFE DIRECTION.



WARNING: ALWAYS ENSURE THAT THE FIREARM IS UNCHARGED AND UNPRIMED BEFORE ATTEMPTING ANY ADJUSTMENTS. FAILURE TO DO THIS CAN CAUSE PERSONAL INJURY OR DEATH TO YOU OR OTHERS.

To adjust elevation, moving the elevation “blade” up or down changes the point of impact. To do this, turn the Elevation Adjustment Screw clockwise (as viewed from the receiver end) to lower the point of impact, and counter-clockwise, to raise the point of impact.

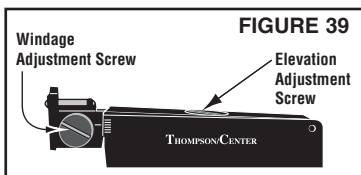

To adjust the windage it is necessary to move the entire rear sight leaf left or right by using the slotted screw head on the right side of the rear sight (as viewed from the receiver end of the sight). Move the rear sight blade in the direction you want your shots to hit-- (Example; Turn the screw clockwise - thereby moving the sight blade to the right, to move your shots to the right and counter-clockwise to move the shots to the left).

LIMITED LIFETIME WARRANTY

This warranty is granted by Smith & Wesson Corp. doing business as Thompson/Center Arms. This warranty is effective from the date of purchase for the lifetime of the original retail purchaser of any factory finished firearm. In order to be eligible for service under this warranty, the original retail purchaser must return a completed authorized warranty card or register online at <http://www.tcarms.com/warranty-details/registration> within thirty (30) days of purchase of such firearm. With respect to such firearm, this warranty supersedes any and all other warranties.

Thompson/Center Arms brand firearms are warranted to be free from defects in material and workmanship. Any such defects of which Smith & Wesson receives written notice by the original retail purchaser will be remedied without charge within a reasonable time after such notification and delivery of the firearm as provided below.

LIMITED LIFETIME WARRANTY CONT'D

Warranty claims (in writing) and the firearm or part thereof concerned should be delivered, postage prepaid, to the factory at Smith & Wesson, 2100 Roosevelt Ave., Springfield, MA 01104, Attn: Service Department. In addition, a copy of the bill of sale in the original retail purchaser's name, or, where applicable, a copy of ATF Form 4473 indicating date of purchase must be included. Please include your physical address and phone number. You must comply with all applicable federal, state and local laws and regulations in the shipment of firearms to Smith & Wesson.

Note: See the Contact & Shipping section of this manual for further details regarding returns.

Warranty claims should state the model and, where applicable, the serial number of the firearm concerned and the description of the difficulty experienced. It is recommended that shipments be insured by the owner, since Smith & Wesson will accept no responsibility for loss or damage in transit. Transportation and insurance charges for return to the owner will be paid by Smith & Wesson if the claim is covered by this warranty.

If the work required is not covered by our "Limited Lifetime Warranty" you will receive a quotation which must be authorized by you. No actual work will be done without your approval. Return shipments can be shipped via UPS, FedEx or mail at your cost. Repaired product will be shipped back to you via FedEx requiring an adult signature upon receipt.

UNDER NO CIRCUMSTANCES SHALL SMITH & WESSON BE RESPONSIBLE FOR INCIDENTAL OR CONSEQUENTIAL DAMAGES WITH RESPECT TO ECONOMIC LOSS, INJURY, DEATH OR PROPERTY DAMAGE, WHETHER AS A RESULT OF BREACH OF THIS WARRANTY, NEGLIGENCE OR OTHERWISE.

Some states do not allow the exclusion or limitation of incidental or consequential damages, so the above limitation or exclusion may not apply to you.

Smith & Wesson will not be responsible for:

- Defects or malfunctions resulting from careless handling, unauthorized adjustments or modifications made or attempted by anyone other than a qualified gunsmith following authorized procedures, or failure to follow the instructions in Safety & Instruction manual that was provided with the firearm from the factory.
- Use of defective or improper ammunition and/or propellant, corrosion, neglect, abuse, ordinary wear and tear, or unreasonable use.
- Use of replacement parts, including but not limited to barrels and springs, other than factory or authorized parts.
- Criminal misuse, negligence, or use under the influence of drugs or alcohol.

LIMITED LIFETIME WARRANTY CONT'D

Services that were performed by the Thompson/Center Arms Custom Shop and/or that are performed by the Smith & Wesson Repair Department do not void this warranty. This warranty gives you specific legal rights, and you may also have other rights which vary from state to state.

Note: All liability is excluded in the event that the instructions provided in the Safety and Instruction manual that was provided with the firearm from the factory are not observed.

CONTACT & SHIPPING INFORMATION

NOTE: A Return Merchandise Authorization (**RMA**) is the first step in the process of returning a product in order to receive a repair, replacement or refund.

Please contact Thompson/Center's Customer Service Dept. (e-mail: tca_customerservice@tcarms.com or by phone at 800-331-0852 ext. 4125) to obtain authorization to return your firearm so we can process it quickly and efficiently. The RMA number that is supplied by Thompson/Center Arms must be displayed on the outside of the returned product's packaging; returns without an RMA number will be routed differently which will result in delayed processing.

The issuance of an Return Merchandise Authorization (**RMA**) allows Thompson/Center Arms an opportunity to try to diagnose and correct a customer's concerns with the product (such as ammunition problems) before it is returned. Accordingly, please contact us before returning your Thompson/Center firearm.

Shipping Address: Thompson/Center Arms
2100 Roosevelt Avenue
Springfield, MA 01104

Should your Thompson/Center firearm require service, it should be returned to the Thompson/Center factory.

- Call or e-mail the Customer Service Dept. for authorization and shipping instructions.
- Ensure that the magazine and chamber are unloaded.
- **Do not attempt to ship a firearm via US Postal Service; only federally licensed dealers may ship a firearm by US Postal Service.**
- **DO NOT SHIP ANY AMMUNITION.**

CONTACT & SHIPPING CONT'D

- Enclose a letter which includes your full name and address (no P.O. Boxes, please), daytime telephone number, e-mail address, the serial number of the firearm, and details of the problem experienced (stating the brand and type of ammunition used when the problem occurred) or work desired.
- Record the serial number before shipping, in case you wish to check on the repair status of your firearm.
- Please remove all custom parts and accessories, such as stocks, special sights and scopes, or slings from your firearm before returning.
- Place the firearm in its original case or in a similarly secure container and pack it securely.
- The package must **NOT** bear any markings which indicate the identity of the contents.
- It is most important that you comply with federal, state, and local laws and regulations. The following guidelines are meant to help, but you must seek assistance from the appropriate authorities if necessary.
- If your firearm must be replaced, it *may* be necessary to ship the replacement to a dealer rather than directly to you. You *may* be requested to furnish a signed FFL (Federal Firearms License) from your dealer in such an instance.
- Warranty repair work will begin upon receipt and examination of the firearm. In the case of repairs or work not covered by the warranty, a quotation covering the cost of the work plus shipping charges will be sent to you. Repairs or modification will be scheduled upon receipt of payment.



WARNING: YOU MAY PURCHASE ACCESSORIES FOR YOUR THOMPSON/CENTER FIREARM. YOU MUST HAVE SOME OF THESE PARTS INSTALLED BY A GUNSMITH QUALIFIED TO PERFORM SERVICE ON THOMPSON/CENTER FIREARMS. NEVER ATTEMPT TO MODIFY YOUR FIREARM OR INSTALL REPLACEMENT PARTS IN YOUR FIREARM. ALWAYS USE A QUALIFIED THOMPSON/CENTER GUNSMITH EVEN IF THE REPAIR SEEMS SIMPLE.

ENCORE[®] SPEED BREECH[®] APPENDIX

This appendix is a supplement to the information provided in the preceding Thompson/Center Encore[®] Magnum Muzzleloader Safety and Instruction Manual. The appendix applies to the specific differences in operation for the Speed Breech[®] and the Swing Hammer[®].

The Encore[®] Pro-Hunter[™] Muzzleloader barrel is equipped with the Speed Breech[®] breech plug system and a rotating extractor for convenience in unloading and cleaning. It differs from the standard Encore muzzleloading barrel in several important aspects as detailed here.

The Encore[®] Pro-Hunter[™] Speed Breech[®] breech plug uses an interrupted "Buttress" thread design that requires only 1/4 turn to remove it or to install it.



WARNING: NEVER ATTEMPT TO REMOVE THE BREECH PLUG FROM YOUR ENCORE MUZZLE-LOADER UNTIL YOU ARE ABSOLUTELY CERTAIN THAT THE FIREARM IS UNPRIMED (PRIMER IS REMOVED FROM THE BREECH PLUG). AN ACCIDENTAL DISCHARGE CAN CAUSE INJURY AND/OR DEATH TO THE SHOOTER OR BYSTANDERS AND DAMAGE TO PROPERTY.

REMOVING THE SPEED BREECH[®] - BREECH PLUG

To remove the breech plug from the Encore Pro-Hunter muzzleloader barrel - the extractor must first be tipped out of the way - to allow the breech plug wrench access. First, tip the barrel open and remove the primer. Then draw the extractor slightly rearward and rotate it 90 degrees (in either direction) to allow clearance for the breech plug wrench (FIGURE 40).

The breech plug is removed from the barrel by turning it 1/4 turn counter-clockwise (as viewed from the breech end of the barrel) with the wrench supplied. The supplied breech plug wrench has a clip which automatically engages a groove in the breech plug when it is pushed onto it - allowing you to easily withdraw the unscrewed breech plug from the barrel (FIGURE 41).

REMOVING A CHARGE FROM THE ENCORE PRO-HUNTER MUZZLELOADER

Under normal conditions, an Encore muzzleloader is unloaded simply by firing it into a suitable and safe backstop. There are, however, some conditions under which the firearm cannot be fired and the charge must be removed. This will require the removal of the breech plug.

ENGORE® Pro-Hunter Speed Breech® CONT'D

Once the breech plug has been removed, point the muzzle up. Gravity should then cause the Pyrodex® pellets to drop out, or the loose powder to pour out. The sabot or bullet can then be pushed out with your ramrod - inserting the ramrod from the muzzle. It will be necessary to add the extended super jag (which came with your rifle) to your ramrod, or you may use the longer "range rod" to push the projectile out - if you have access to such a rod.

To release the breech plug from the wrench for cleaning, push forward on the sliding button to raise the clip out of the groove in the breech plug (FIGURE 41).

Proceed to clean the breech plug, the barrel itself and the internal threads in the barrel's breech area as needed.

FIGURE 40



FIGURE 41

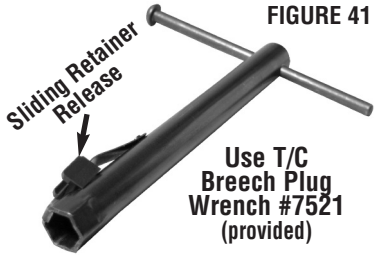

FIGURE 42

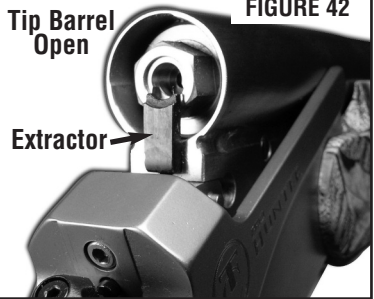

FIGURE 43



ENCORE® Pro-Hunter Speed Breech® CONT'D

You can now re-install the breech plug into the barrel with the supplied wrench - with the extractor slot oriented to the right and the alignment pin is oriented to the left (as viewed from the breech end of the barrel) (FIGURE 45). Tighten the breech plug into place by seating it fully into the barrel and turning it clockwise just 1/4 turn - at which point the extractor is aligned with the extractor slot in the breech plug when the extractor is tipped back into the upright position.

NOTE: If the breech plug is not installed correctly, the extractor will not engage the extractor slot in the breech plug and the barrel will not close on the gun's frame.

Push forward on the sliding button on the wrench to raise the clip out of the groove in the breech plug - allowing you to remove the wrench from the breech plug (FIGURE 47).

This breech plug has a replaceable heat-resistant O-Ring that seals the breech area further against fouling residue (FIGURE 49). This O-Ring can be easily replaced if it should become damaged. Use T/C Part No.7531 replacement O-Rings - available from your dealer - or by contacting the factory.

The gas rings (shown in FIGURE 49) are designed to be a permanent assembly with the breech plug. They should be cleaned in place with a brush and solvent (like T/C's Number 13® Bore Cleaner).

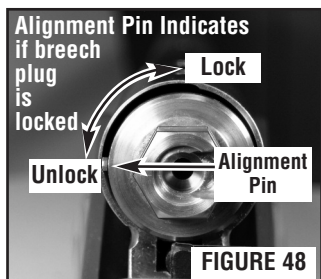
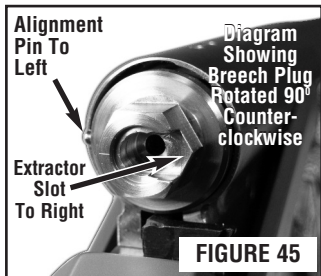

ENCORE® Pro-Hunter Speed Breech® CONT'D

IMPORTANT: When re-installing the breech plug after cleaning your muzzleloader, you should lubricate the entire surface area of the threads on the breech plug with a good anti-seize lubricant (like Thompson/Center's Super Lube) as well as the threads inside the breech area of the barrel itself. Failure to lubricate the threads in both places may lead to difficulty in removing the breech plug after firing the gun (FIGURE 50).

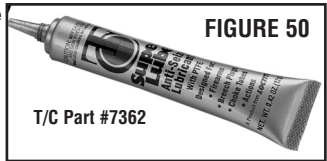
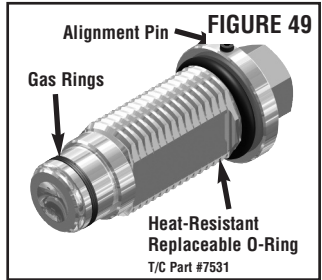

WARNING: ALWAYS HAVE ADEQUATE VENTILATION. CLEANING FIREARMS IN POORLY VENTILATED AREAS, DISCHARGING FIREARMS, OR HANDLING AMMUNITION AND LOADING COMPONENTS MAY RESULT IN EXPOSURE TO LEAD AND OTHER SUBSTANCES KNOWN TO CAUSE BIRTH DEFECTS, REPRODUCTIVE HARM AND OTHER SERIOUS PHYSICAL INJURY. WASH HANDS THOROUGHLY AFTER EXPOSURE.

ENCORE[®] SWING HAMMER[®] APPENDIX

Use & Care of the ENCORE[®] Swing Hammer[®] System

- To make it easier to cock your Encore[®] Pro-Hunter when a scope is mounted, it comes with a pivoting spur hammer. The Swing Hammer[®] can be locked into a left, center or right position - depending on your preference.

WARNING: BEFORE MAKING ANY CHANGES TO THE ENCORE, MAKE SURE THAT THE FIREARM YOU ARE WORKING WITH IS UNLOADED. AN ACCIDENTAL DISCHARGE MAY RESULT IN INJURY AND/OR DEATH TO THE SHOOTER OR BYSTANDERS AND DAMAGE TO PROPERTY.

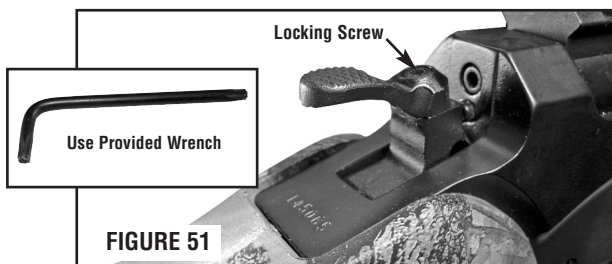

- The Encore Swing Hammer[®] uses one self-locking screw to hold the spur in the position that you choose. A wrench is provided from the factory (FIGURE 51).

• If you want to change the position of the hammer spur - and the scope bell interferes - it may be necessary to tip the barrel open to gain access to the locking screw.

- Loosen the locking screw by turning it counter-clockwise (as viewed from above) until the screw either comes out completely or it is loose enough to allow easy movement of the hammer spur (FIGURE 52). After repositioning the hammer spur, tighten the locking screw securely.



ENCORE® SWING HAMMER® CONT'D

NOTE: The Swing Hammer® will not tighten down correctly in any position other than those shown.

- For those Encores not equipped with this option, it is available as a factory-installed accessory. Contact us for details. Once installed - the shooter can alter the position of the hammer as directed here.

ENCORE® ENDEAVOR SPEED BREECH® XT™ APPENDIX

This appendix is a supplement to the information provided in the preceding Thompson/Center Encore Muzzleloader Safety and Instruction Manual. The appendix applies to the specific differences in operation for the Speed Breech® XT™ that the Encore Endeavor employs (FIGURE 53).

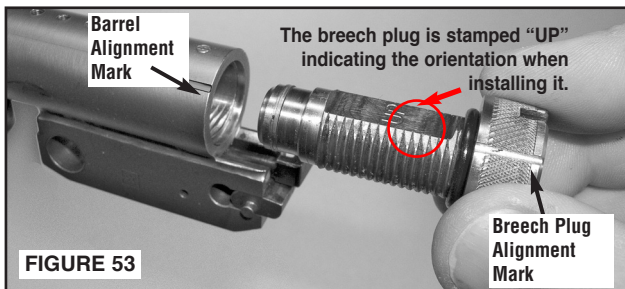

The Encore Endeavor Muzzleloader barrel is equipped with a Speed Breech® XT™ breech plug system and a rotating extractor for convenience in unloading and cleaning. The Encore Endeavor differs from the other Encore muzzleloaders in the aspects detailed here:

The Encore Endeavor Speed Breech® XT™ breech plug uses an interrupted "Buttress" thread design that requires only 1/4 turn to remove it or to install it.

WARNING: NEVER ATTEMPT TO REMOVE THE BREECH PLUG FROM YOUR ENCORE MUZZLE-LOADER UNTIL YOU ARE ABSOLUTELY CERTAIN THAT THE FIREARM IS UNPRIMED (PRIMER IS REMOVED FROM THE BREECH PLUG). AN ACCIDENTAL DISCHARGE CAN CAUSE INJURY AND/OR DEATH TO THE SHOOTER OR BYSTANDERS AND DAMAGE TO PROPERTY.

REMOVING THE SPEED BREECH® XT™ - BREECH PLUG

- First, open the action, remove any primer from the breech plug.
- To remove the breech plug from the Encore Endeavor muzzleloader barrel - first, draw the extractor fully rearward and rotate it 90 degrees as shown to allow clearance (FIGURES 54 to 56).
- Remove the breech plug by turning it 1/4 turn counter-clockwise (as viewed from the breech end of the barrel) by hand or with the wrench supplied (FIGURES 57 & 58) and then withdrawing it from the barrel (FIGURE 59). If the breech plug doesn't come out readily using your fingers, a tap from the ramrod inserted down the barrel from the muzzle should do the trick.

REMOVING A CHARGE FROM THE ENCORE® ENDEAVOR™ MUZZLELOADER

Under normal conditions, an Encore Endeavor muzzleloader is unloaded simply by firing it into a suitable and safe backstop. There are, however, some conditions under which the firearm cannot be fired and the charge must be removed. This will require the removal of the breech plug.

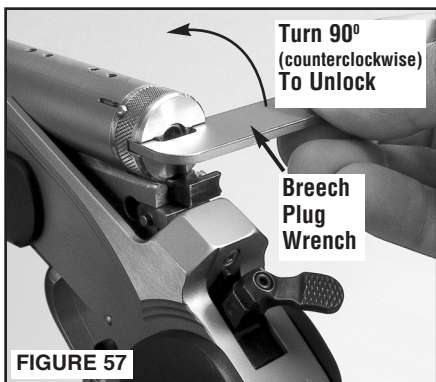
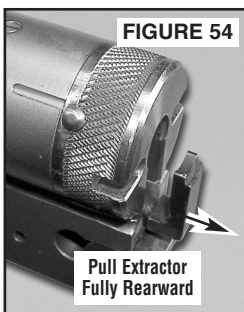

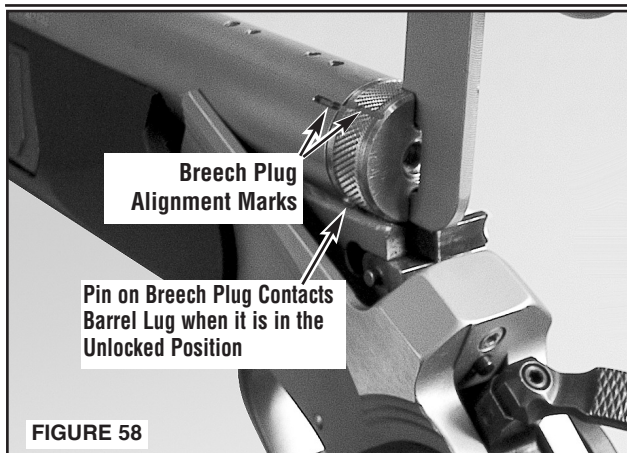

Once the breech plug has been removed, point the muzzle up. Gravity should then cause the black powder or pellets to drop out. The sabot or bullet can then be pushed out with your ramrod - inserting the ramrod from the muzzle. It will be necessary to add the extended super jag (which came with your rifle) to your ramrod, or you may use the longer "range rod" to push the projectile out - if you have access to such a rod.

Proceed to clean the breech plug, the barrel itself and the internal threads in the barrel's breech area as needed.

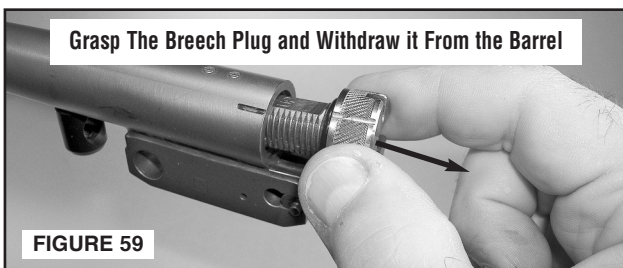

! WARNING: ALWAYS HAVE ADEQUATE VENTILATION. CLEANING FIREARMS IN POORLY VENTILATED AREAS, DISCHARGING FIREARMS, OR HANDLING AMMUNITION AND LOADING COMPONENTS MAY RESULT IN EXPOSURE TO LEAD AND OTHER SUBSTANCES KNOWN TO CAUSE BIRTH DEFECTS, REPRODUCTIVE HARM AND OTHER SERIOUS PHYSICAL INJURY. WASH HANDS THOROUGHLY AFTER EXPOSURE.

Re-install the breech plug into the barrel - with the "UP" marking oriented in that manner (FIGURE 60). Tighten the breech plug into place by turning it clockwise just 1/4 turn. At this point the extractor is aligned with the extractor slot in the breech plug - when the extractor is tipped back into the upright position (FIGURE 51).

NOTE: If the breech plug is not installed correctly, the extractor will not engage the extractor slot in the breech plug and the barrel will not close on the gun's frame.

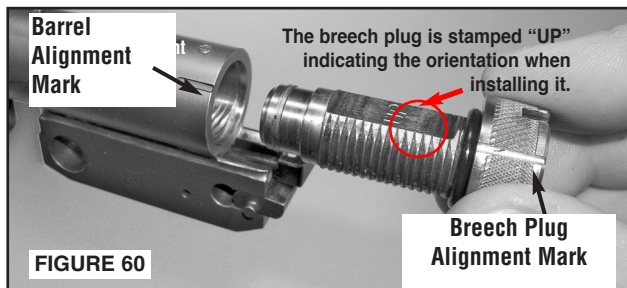

The breech plug has a replaceable heat-resistant O-Ring that seals the breech area further against fouling residue (FIGURE 62). This O-Ring can be easily replaced if it should become damaged.

Use T/C Part No.7531 replacement O-Rings - available from your dealer - or from the Thompson/Center factory.

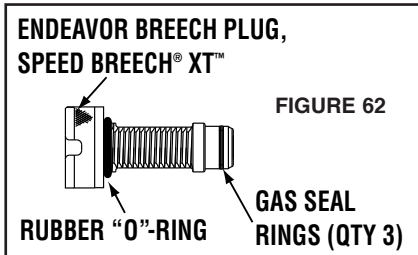

The gas seal rings (FIGURE 62) are designed to be a permanent assembly with the breech plug. They should be cleaned in place with a brush and solvent (T/C's Number 13® Bore Cleaner or T17® Bore Cleaner works well for this).

IMPORTANT: When re-installing the breech plug after cleaning your muzzleloader, you should lubricate the entire surface area of the threads on the breech plug with a good anti-seize lubricant



(T/C's Super Lube™ - FIG. 63) as well as the threads inside the breech area of the barrel itself. Failure to lubricate the threads in both places may lead to difficulty in removing the breech plug after firing the gun.

LOAD COMPONENTS

 **WARNING: NEVER USE LOADING COMPONENTS NOT SPECIFICALLY REFERENCED IN THIS MANUAL. FAILURE TO FOLLOW THIS RULE MAY CAUSE EXCESSIVE PRESSURE WHICH CAN DAMAGE OR EVEN RUPTURE YOUR FIREARM, CAUSING PERSONAL INJURY, DEATH OR PROPERTY DAMAGE.**

- **USE ONLY BLACK POWDER OR AN APPROVED BLACK POWDER SUBSTITUTE SUCH AS PYRODEX® TO LOAD YOUR MUZZLELOADING FIREARM.** Never use even small amounts of smokeless powder, even if it is black in color. The use of any other propellant may cause injury or death to the shooter or bystanders and damage to property.
- **YOU ARE RESPONSIBLE FOR USING THE CORRECT COMBINATION OF LOAD COMPONENTS IN YOUR ENCORE MUZZLELOADER** as detailed in this manual.

NOTE: Different combinations of bullet weight and powder charge can have a major effect on felt recoil. Heavier bullets and heavier powder charges will result in more recoil.

 **WARNING: DEATH, SERIOUS INJURY AND DAMAGE TO PROPERTY CAN RESULT FROM THE USE OF INCORRECT LOAD COMPONENTS.**

SUGGESTED LOADS FOR THE ENCORE® MUZZLELOADER

 **WARNING: ALWAYS KEEP THE MUZZLE POINTED IN A SAFE DIRECTION.**

The following charts show recommended charges using Black Powder or a Pyrodex equivalent as the propellant for Thompson/Center Encore muzzleloading rifles and pistols. Charges are listed by caliber, powder charge and type of projectile.

Note that in each instance a series of charges are listed. More than one charge is shown in each category to clearly illustrate the appropriate powder charge range for that particular caliber, gun model and projectile.

 **WARNING: MAXIMUM LOADS ARE NOT TO BE EXCEEDED NOR IS A SUBSTITUTION OF POWDER OR GRANULATIONS TO BE ATTEMPTED! ONLY USE LOADS THAT ARE LISTED FOR YOUR PARTICULAR CALIBER, MODEL AND BULLET STYLE. FAILURE TO FOLLOW THESE INSTRUCTIONS MAY RESULT IN INJURY AND/OR DEATH TO THE SHOOTER OR BYSTANDERS AND DAMAGE TO PROPERTY.**

SUGGESTED LOADS CONT'D

The shooter is instructed to start with the lightest charge listed. As you become familiar with the firearm, increase your charges gradually until you reach your best performing load (most accurate). Thompson/Center Arms is not responsible for loading information printed in sources other than this booklet.

NOTE: All loading data contained in this book is the result of testing by Thompson/Center Arms. Testing was done under carefully controlled conditions with the components specified in the text.

Since Thompson/Center has no control over the components or equipment which may be used with this information, no responsibility is implied or assumed for the results obtained.



WARNING: THE LOADING DATA FOUND IN THIS MANUAL WAS COMPILED USING BLACK POWDER OR PYRODEX® AS A PROPELLANT. WITH ANY OTHER APPROVED BLACK POWDER SUBSTITUTE FOLLOW THE INSTRUCTIONS SUPPLIED BY THE MANUFACTURER AND HEED ALL WARNINGS AS THEY APPLY TO LOADING AND USAGE OF THAT PRODUCT.

Assembly & Loading T/C Mag Express® & Shock Wave® Sabots

T/C® sabots come in several variations; Insert the correct diameter bullet into the sabot and press firmly, making sure the bullet is fully seated within the sabot - and that the sabot is firmly seated on the powder charge when loading (FIGURE 64).

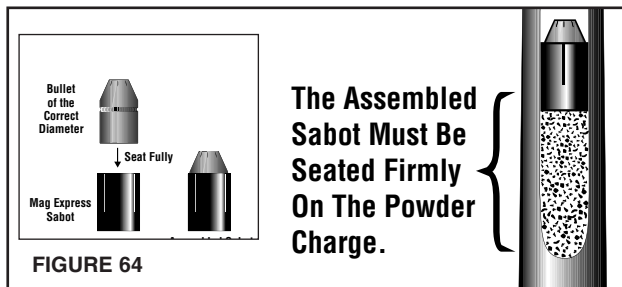

MAG EXPRESS® & SHOCK WAVE® SABOTS CONT'D

 **WARNING: WHEN LOADING T/C'S MAG EXPRESS® SABOTS, MAKE SURE THAT YOUR GUN IS UNPRIMED, AND THAT YOUR SABOT HAS BEEN PROPERLY ASSEMBLED. FAILURE TO ASSEMBLE AND LOAD YOUR SABOT CORRECTLY COULD RESULT IN THE BULLET DISENGAGING FROM THE SABOT. THIS COULD RESULT IN AN AIR SPACE BETWEEN THE COMPONENTS. UNDER SUCH A CONDITION, ONE OR MORE OF THE COMPONENTS MAY ACT AS A BARREL OBSTRUCTION AND FIRING COULD RESULT IN INJURY AND/OR DEATH TO THE SHOOTER OR BYSTANDERS AND DAMAGE TO PROPERTY.**

 **WARNING: USE ONLY PROJECTILES OF THE CORRECT DIAMETER THAT WERE DESIGNED FOR THE SABOTS YOU ARE USING. USING BULLETS OF LESSER DIAMETER MAY CAUSE THE BULLET TO SEPARATE FROM THE SABOT RESULTING IN A BARREL OBSTRUCTION. USING BULLETS OF LARGER DIAMETER COULD RESULT IN DIFFICULT LOADING, OR A CONDITION WHERE THE SABOT IS NOT SEATED ALL THE WAY DOWN ON THE POWDER CHARGE, RESULTING IN A BARREL OBSTRUCTION. EITHER CASE CAN RESULT IN A DAMAGED FIREARM AND POSSIBLE INJURY AND/OR DEATH TO THE SHOOTER OR BYSTANDERS AND DAMAGE TO PROPERTY.**

 **WARNING: THE LOAD DATA PROVIDED HERE IS FOR USE IN RIFLES OF THOMPSON/CENTER MANUFACTURE ONLY. FOR LOAD DATA FOR OTHER BRANDS REFER TO THEIR LOADING DATA.**

ENCORE® RIFLE SECTION

T/C® Mag Express® Sabot Loads



For Use in a .50 Caliber Encore® Muzzleloading Rifle Only Using Bullet Weights Listed Use #209 Primer for Ignition		.50 Caliber Rifle Using Pyrodex® Pellets & Mag Express® Sabot Loads	
For Use With Bullets Weighing (Grains)	Powder Charge 50 Cal/50 Grain PYRODEX® PELLETS	Muzzle Velocity (Feet Per Second)	Muzzle Energy (Foot Pounds)
180 Gr. Bullet	2 Pellets	1937 F.P.S.	1500 Ft. Lbs.
	3 Pellets	2303 F.P.S.	2120 Ft. Lbs.
240 Gr. Bullet	2 Pellets	1889 F.P.S.	1902 Ft. Lbs.
	3 Pellets	2249 F.P.S.	2696 Ft. Lbs.
250 Gr. Bullet	2 Pellets	1863 F.P.S.	1927 Ft. Lbs.
	3 Pellets	2197 F.P.S.	2680 Ft. Lbs.
300 Gr. Bullet	2 Pellets	1729 F.P.S.	1992 Ft. Lbs.
	3 Pellets	2036 F.P.S.	2762 Ft. Lbs.
325 Gr. Bullet	2 Pellets	1624 F.P.S.	1903 Ft. Lbs.
	3 Pellets	1938 F.P.S.	2711 Ft. Lbs.
400 Gr. Bullet	2 Pellets	1512 F.P.S.	2031 Ft. Lbs.
	3 Pellets	1806 F.P.S.	2897 Ft. Lbs.

Load Shown in Red is Maximum

For Use With .50 Caliber Encore® Muzzleloading Rifle Only Using Bullet Weights Listed Use #209 Primer for Ignition		.50 Caliber Rifle Using Black Powder & Mag Express® Sabot Loads	
For Use With Bullets Weighing (Grains)	Black Powder Charge (Grains)	Muzzle Velocity (Feet Per Second)	Muzzle Energy (Foot Pounds)
180 Grain Bullet Like The Thompson/Center XTP™	80 grs. FFG	1609 F.P.S.	1035 Ft. Lbs.
	90 grs. FFG	1685 F.P.S.	1135 Ft. Lbs.
	100 grs. FFG	1737 F.P.S.	1206 Ft. Lbs.
	110 grs. FFG	1766 F.P.S.	1247 Ft. Lbs.
	120 grs. FFG	1852 F.P.S.	1371 Ft. Lbs.
	130 grs. FFG	1907 F.P.S.	1454 Ft. Lbs.
	140 grs. FFG	2004 F.P.S.	1606 Ft. Lbs.
	150 grs. FFG	2043 F.P.S.	1669 Ft. Lbs.
240 Grain Bullet Like The Thompson/Center XTP™	80 grs. FFG	1511 F.P.S.	1217 Ft. Lbs.
	90 grs. FFG	1629 F.P.S.	1414 Ft. Lbs.
	100 grs. FFG	1672 F.P.S.	1490 Ft. Lbs.
	110 grs. FFG	1710 F.P.S.	1559 Ft. Lbs.
	120 grs. FFG	1761 F.P.S.	1653 Ft. Lbs.
	130 grs. FFG	1794 F.P.S.	1716 Ft. Lbs.
	140 grs. FFG	1846 F.P.S.	1816 Ft. Lbs.
	150 grs. FFG	1879 F.P.S.	1882 Ft. Lbs.
250 Grain Bullet Like The Thompson/Center PTX™	80 grs. FFG	1472 F.P.S.	1203 Ft. Lbs.
	90 grs. FFG	1601 F.P.S.	1423 Ft. Lbs.
	100 grs. FFG	1642 F.P.S.	1497 Ft. Lbs.
	110 grs. FFG	1696 F.P.S.	1597 Ft. Lbs.
	120 grs. FFG	1724 F.P.S.	1650 Ft. Lbs.
	130 grs. FFG	1775 F.P.S.	1749 Ft. Lbs.
	140 grs. FFG	1828 F.P.S.	1855 Ft. Lbs.
	150 grs. FFG	1853 F.P.S.	1907 Ft. Lbs.
300 Grain Bullet Like The Thompson/Center XTP™	80 grs. FFG	1452 F.P.S.	1405 Ft. Lbs.
	90 grs. FFG	1535 F.P.S.	1570 Ft. Lbs.
	100 grs. FFG	1601 F.P.S.	1708 Ft. Lbs.
	110 grs. FFG	1646 F.P.S.	1805 Ft. Lbs.
	120 grs. FFG	1667 F.P.S.	1852 Ft. Lbs.
	130 grs. FFG	1693 F.P.S.	1910 Ft. Lbs.
	140 grs. FFG	1714 F.P.S.	1957 Ft. Lbs.
	150 grs. FFG	1758 F.P.S.	2015 Ft. Lbs.

Load Shown in Red is Maximum - Heavier Bullets continued next page...

T/C Mag Express® Sabot Loads CONT'D.

... continued from previous page.

**For Use With .50 Caliber
Encore® Muzzleloading Rifle Only
Using Bullet & Sabot Listed Below
Use #209 Primer for Ignition**

**.50 Caliber Rifle
Using Black Powder &
Mag Express® Sabot Loads**

For Use With Bullets Weighing (Grains)	Black Powder Charge (Grains)	Muzzle Velocity (Feet Per Second)	Muzzle Energy (Foot Pounds)
325 Grain Bullet	100 grs. FFG	1451 F.P.S.	1520 Ft. Lbs.
	120 grs. FFG	1555 F.P.S.	1745 Ft. Lbs.
	150 grs. FFG	1710 F.P.S.	2110 Ft. Lbs.
400 Grain Bullet	100 grs. FFG	1390 F.P.S.	1679 Ft. Lbs.
	120 grs. FFG	1469 F.P.S.	1917 Ft. Lbs.
	150 grs. FFG	1587 F.P.S.	2238 Ft. Lbs.

Load Shown in Red is Maximum



SHOCK WAVE® SABOT LOADS

For Use With .50 Caliber Encore® Muzzleloading Rifle Only Using Bullet & Sabot Listed Below Use #209 Primer for Ignition		.50 Caliber Rifle Using 50 Gr. Equivalent Pyrodex® Pellets & Shock Wave® Bullets with T/C Super Glide™ Sabots	
For Use With Bullets Weighing (Grains)	Powder Charge 50 CAL/50 GR PYRODEX PELLETS	Muzzle Velocity (Feet Per Second)	Muzzle Energy (Foot Pounds)
250 Gr. Bullet Shock Wave® in the T/C Super Glide™ Sabot	2 Pellets	1863 F.P.S.	1927 Ft. Lbs.
	3 Pellets	2197 F.P.S.	2680 Ft. Lbs.
300 Gr. Bullet Shock Wave® in the T/C Super Glide™ Sabot	2 Pellets	1729 F.P.S.	1992 Ft. Lbs.
	3 Pellets	2036 F.P.S.	2762 Ft. Lbs.
Load Shown in Red is Maximum			



For Use With .50 Caliber Encore® Muzzleloading Rifle Only Using Bullet & Sabot Listed Below Use #209 Primer for Ignition		.50 Caliber Rifle Using Black Powder & Shock Wave® Bullets with T/C Super Glide™ Sabots	
For Use With Bullets Weighing (Grains)	Black Powder Charge (Grains)	Muzzle Velocity (Feet Per Second)	Muzzle Energy (Foot Pounds)
250 Gr. Bullet Shock Wave® in the T/C Super Glide™ Sabot	80 grs. FFG	1472 F.P.S.	1203 Ft. Lbs.
	90 grs. FFG	1601 F.P.S.	1423 Ft. Lbs.
	100 grs. FFG	1642 F.P.S.	1497 Ft. Lbs.
	110 grs. FFG	1696 F.P.S.	1597 Ft. Lbs.
	120 grs. FFG	1724 F.P.S.	1650 Ft. Lbs.
	130 grs. FFG	1775 F.P.S.	1749 Ft. Lbs.
	140 grs. FFG	1828 F.P.S.	1855 Ft. Lbs.
	150 grs. FFG	1853 F.P.S.	1907 Ft. Lbs.
300 Gr. Bullet T/C Shock Wave® in the T/C Super Glide™ Sabot	80 grs. FFG	1452 F.P.S.	1405 Ft. Lbs.
	90 grs. FFG	1535 F.P.S.	1570 Ft. Lbs.
	100 grs. FFG	1601 F.P.S.	1708 Ft. Lbs.
	110 grs. FFG	1646 F.P.S.	1805 Ft. Lbs.
	120 grs. FFG	1667 F.P.S.	1852 Ft. Lbs.
	130 grs. FFG	1693 F.P.S.	1910 Ft. Lbs.
	140 grs. FFG	1714 F.P.S.	1957 Ft. Lbs.
	150 grs. FFG	1758 F.P.S.	2015 Ft. Lbs.
Load Shown in Red is Maximum			

Loading T/C Maxi-Ball™ & Maxi-Hunter® Conical Lead Bullets

For Use Only With .50 Caliber Encore® Muzzleloading Rifle Only Bullets Lubricated with Natural Lube 1000 Plus™ Bore Butter. Use #209 Primer for Ignition		.50 Caliber Rifle Using Pyrodex® Pellets & Maxi-Ball™ or Maxi-Hunter®	
For Use With .50 cal Bullets Weighing (Grains)	Powder Charge 50 CAL/50 GR PYRODEX PELLETS	Muzzle Velocity (Feet Per Second)	Muzzle Energy (Foot Pounds)
275 Gr. Maxi-Hunter® & 320 Gr. Maxi-Ball™	2 Pellets	1718 F.P.S.	2098 Ft. Lbs.
	3 Pellets	2026 F.P.S.	2917 Ft. Lbs.
350 Gr. Maxi-Hunter® & 370 Gr. Maxi-Ball™	2 Pellets	1656 F.P.S.	2253 Ft. Lbs.
	3 Pellets	1891 F.P.S.	2939 Ft. Lbs.
Load Shown in Red is Maximum			

For Use Only With .50 Caliber Encore® Muzzleloading Rifle Only Bullets Lubricated with Natural Lube 1000 Plus™ Bore Butter. Use #209 Primer for Ignition		.50 Caliber Rifle Using Black Powder & Maxi-Ball™ or Maxi-Hunter®	
For Use With .50 cal Bullets Weighing (Grains)	Black Powder Charge (Grains)	Muzzle Velocity (Feet Per Second)	Muzzle Energy (Foot Pounds)
275 Grain Maxi-Hunter® and 320 Grain Maxi-Ball™ Lead Bullet	80 grs. FFG	1408 F.P.S.	1409 Ft. Lbs.
	90 grs. FFG	1462 F.P.S.	1519 Ft. Lbs.
	100 grs. FFG	1511 F.P.S.	1623 Ft. Lbs.
	110 grs. FFG	1588 F.P.S.	1792 Ft. Lbs.
	120 grs. FFG	1632 F.P.S.	1893 Ft. Lbs.
	130 grs. FFG	1675 F.P.S.	1994 Ft. Lbs.
	140 grs. FFG	1697 F.P.S.	2020 Ft. Lbs.
	150 grs. FFG	1742 F.P.S.	2157 Ft. Lbs.
350 Grain Maxi-Hunter® and 370 Grain Maxi-Ball™ Lead Bullet	80 grs. FFG	1344 F.P.S.	1484 Ft. Lbs.
	90 grs. FFG	1426 F.P.S.	1671 Ft. Lbs.
	100 grs. FFG	1478 F.P.S.	1795 Ft. Lbs.
	110 grs. FFG	1535 F.P.S.	1936 Ft. Lbs.
	120 grs. FFG	1556 F.P.S.	1990 Ft. Lbs.
	130 grs. FFG	1592 F.P.S.	2083 Ft. Lbs.
	140 grs. FFG	1623 F.P.S.	2165 Ft. Lbs.
	150 grs. FFG	1661 F.P.S.	2267 Ft. Lbs.
Load Shown in Red is Maximum			

ENCORE® PISTOL SECTION

Conical Lead Bullets

For Use Only With .50 Caliber Encore® Muzzleloading Pistol Only Bullets Lubricated with Natural Lube 1000 Plus™ Bore Butter Use a #209 Primer for Ignition		.50 Caliber PISTOL Using Black Powder & Maxi-Ball™ or Maxi-Hunter®	
For Use With .50 cal Bullets Weighing (Grains)	Black Powder Charge (Grains)	Muzzle Velocity (Feet Per Second)	Muzzle Energy (Foot Pounds)
275 Gr. Maxi-Hunter® and 320 Gr. Maxi-Ball™ Lead Bullet	80 grs. FFG	1235 F.P.S.	1084 Ft. Lbs.
	90 grs. FFG	1269 F.P.S.	1145 Ft. Lbs.
	100 grs. FFG	1336 F.P.S.	1269 Ft. Lbs.
	110 grs. FFG	1387 F.P.S.	1367 Ft. Lbs.
350 Gr. Maxi-Hunter® and 370 Gr. Maxi-Ball™ Lead Bullet	80 grs. FFG	1187 F.P.S.	1484 Ft. Lbs.
	90 grs. FFG	1240 F.P.S.	1671 Ft. Lbs.
	100 grs. FFG	1275 F.P.S.	1795 Ft. Lbs.
	110 grs. FFG	1303 F.P.S.	1936 Ft. Lbs.
470 Gr. Maxi-Hunter® and 460 Gr. Maxi-Ball™ Lead Bullet	80 grs. FFG	1080 F.P.S.	1192 Ft. Lbs.
	90 grs. FFG	1130 F.P.S.	1305 Ft. Lbs.
	100 grs. FFG	1160 F.P.S.	1375 Ft. Lbs.
	110 grs. FFG	1186 F.P.S.	1437 Ft. Lbs.
Load Shown in Red is Maximum			

ENCORE® PISTOL SECTION

For Use Only With .50 Caliber Encore® Muzzleloading Pistol Only Bullets Lubricated with Natural Lube 1000 Plus™ Bore Butter Use a #209 Primer for Ignition		.50 Caliber PISTOL Using Pyrodex® Pellets & Maxi-Ball™ or Maxi-Hunter®	
50 Grain Equivalent Pyrodex® Pellet Loading Data			
For Use With .50 cal Bullets Weighing (Grains)	Powder Charge .50 cal/50 gr. Pyrodex® Pellets	Muzzle Velocity (Feet Per Second)	Muzzle Energy (Foot Pounds)
275 Gr. Maxi-Hunter® & 320 Gr. Maxi-Ball™	2 Pellets	1505 F.P.S.	1609 Ft. Lbs.
350 Gr. Maxi-Hunter® & 370 Gr. Maxi-Ball™	2 Pellets	1473 F.P.S.	1783 Ft. Lbs.
470 Gr. Maxi-Hunter® & 460 Gr. Maxi-Ball™	2 Pellets	1297 F.P.S.	1719 Ft. Lbs.
Load Shown in Red is Maximum			

Mag Express® Sabots

ENCORE® PISTOL SECTION

For Use Only With .50 Caliber Encore® Muzzleloading Pistol Only Using a .429"-.430" Bullet Use a #209 Primer for Ignition		.50 Caliber PISTOL Using Black Powder & Mag Express® Sabot Loads	
For Use With Bullets Weighing (Grains)	Black Powder Charge (Grains)	Muzzle Velocity (Feet Per Second)	Muzzle Energy (Foot Pounds)
200 Grain Bullet	80 grs. FFG	1360 F.P.S.	829 Ft. Lbs.
	90 grs. FFG	1420 F.P.S.	896 Ft. Lbs.
	100 grs. FFG	1479 F.P.S.	972 Ft. Lbs.
	110 grs. FFG	1530 F.P.S.	1039 Ft. Lbs.
240 Grain Bullet	80 grs. FFG	1306 F.P.S.	909 Ft. Lbs.
	90 grs. FFG	1379 F.P.S.	1014 Ft. Lbs.
	100 grs. FFG	1416 F.P.S.	1069 Ft. Lbs.
	110 grs. FFG	1454 F.P.S.	1124 Ft. Lbs.
275 Grain Bullet	80 grs. FFG	1272 F.P.S.	988 Ft. Lbs.
	90 grs. FFG	1335 F.P.S.	1089 Ft. Lbs.
	100 grs. FFG	1391 F.P.S.	1182 Ft. Lbs.
	110 grs. FFG	1447 F.P.S.	1270 Ft. Lbs.
300 Grain Bullet	80 grs. FFG	1268 F.P.S.	1071 Ft. Lbs.
	90 grs. FFG	1313 F.P.S.	1149 Ft. Lbs.
	100 grs. FFG	1372 F.P.S.	1254 Ft. Lbs.
	110 grs. FFG	1417 F.P.S.	1328 Ft. Lbs.
Load Shown in Red is Maximum			

Mag Express® Sabots

ENCORE® PISTOL SECTION

For Use Only With .50 Caliber Encore® Muzzleloading Pistol Only Using a .429"-.430" Bullet Use a #209 Primer for Ignition		.50 Caliber PISTOL Using Pyrodex Pellets & Mag Express® Sabot Loads	
50 Grain Equivalent Pyrodex® Pellet Loading Data			
For Use With Bullets Weighing (Grains)	Powder Charge .50 cal/50 gr. Pyrodex® Pellets	Muzzle Velocity (Feet Per Second)	Muzzle Energy (Foot Pounds)
200 Gr. Bullet	2 Pellets	1760 F.P.S.	1376 Ft. Lbs.
240 Gr. Bullet	2 Pellets	1659 F.P.S.	1467 Ft. Lbs.
275 Gr. Bullet	2 Pellets	1583 F.P.S.	1530 Ft. Lbs.
300 Gr. Bullet	2 Pellets	1550 F.P.S.	1601 Ft. Lbs.
Load Shown in Red is Maximum			

NOTES

FOR YOUR RECORDS

Important Note: For fire, theft and insurance purposes, retain this record with your important papers in a safe place.

My Thompson/Center: _____

Was Purchased From: _____

On (date): _____ 20_____

Serial Number: _____ **Caliber:** _____

Accessories: _____

Owner Registration Card Mailed on: _____

Notes: _____

This area is provided for your convenience. We suggest that you make a list of important information that pertains to your specific firearm (best performing load, etc.). Keep this booklet with your firearm and review your notes before each hunting season or whenever the firearm has not been used for extended periods of time.

PATENT INFO

This product may be covered by one or more patents. Visit www.tcarms.com for virtual patent information.

T/C Mailing Address:
(for questions & comments)

Thompson/Center Arms

2100 Roosevelt Avenue • Springfield, MA 01104

T/C Shipping Address:
(for repairs or warranty work)

Thompson/Center Arms

ATTN: Repair Department

2100 Roosevelt Avenue • Springfield, MA 01104

Web Address:

www.tcarms.com

Customer Service Phone:

Toll Free (866) 730-1614

Customer Service email:

tca_customerservice@tcarms.com