

ZULUS SERIES



Digital Day & Night Scope

CONTENTS

ZULUS SERIES DIGITAL DAY & NIGHT SCOPE

General Information	01
Product Specifications	02
Features	03
Controls & Buttons	04
Main Functions	06
APP Connection	23
Firmware Update	24

ZULUS SERIES

DIGITAL DAY & NIGHT SCOPE

Safety Instructions

Read and follow all instructions

Read all warnings!

Do not attempt to disassemble the device by yourself, all services must be provided by the manufacturer

CAUTION

- ⦿ DO NOT look directly into the INFRARED (IR) Illuminator to avoid damages to your eyes.
- ⦿ Switch off the IR Illuminator when not in use. Continuous use of IR light will generate excessive heat. Avoid pointing it towards flammable objects.
- ⦿ Device operating temperature -4F-122F (-20~50°C).

Description

The Zulus Series Digital Scope is compact, designed to be used around the clock and in any weather condition. With its excellent day/night image quality, it's ideal for hunting and shooting sports.

The built-in LASER Rangefinder paired with the ballistic calculator, assists in accurate shot placement.

Package Content

- ZULUS Scope
- Rail Accessories
- Eye Cup
- USB Cable
- User Manual

Product Specifications

	Model	ZHD 3-12x	ZHD 3-12x LRF	ZHD 5-20x	ZHD 5-20x LRF
Sensor Specifications	Resolution	1920 x 1080 pixels	1920 x 1080 pixels	1920 x 1080 pixels	1920 x 1080 pixels
	Frame Rate	60Hz	60Hz	60Hz	60Hz
	Video Record Resolution	1920 x 1080 pixels	1920 x 1080 pixels	1920 x 1080 pixels	1920 x 1080 pixels
Optical Specifications	Digital Magnification	3 ~ 12x	3 ~ 12x	5 ~ 20x	5 ~ 20x
	Eye Relief	45mm / 1.8Inches	45mm / 1.8Inches	45mm / 1.8Inches	45mm / 1.8Inches
	Diopter Adjustment	± 5D	± 5D	± 5D	± 5D
Display Specifications	Type	Micro - OLED	Micro - OLED	Micro - OLED	Micro - OLED
	Display Resolution	1920 x 1080 pixels	1920 x 1080 pixels	1920 x 1080 pixels	1920 x 1080 pixels
	Frame Rate	60Hz	60Hz	60Hz	60Hz
Power Specifications	Battery Type	18650 Battery(flat-top)	18650 Battery(flat-top)	18650 Battery(flat-top)	18650 Battery(flat-top)
	Operating Time	8h	8h	8h	8h
	External Power Supply	5V - Type C USB	5V - Type C USB	5V - Type C USB	5V - Type C USB
Physical Specifications	Net Weight	396g / 14.0oz	465g / 16.4oz	419g / 14.8oz	481g / 17.0oz
	Gross Weight(w/battery,mount,eyepiece)	581g / 20.5oz	650g / 22.9oz	604g / 21.3oz	666g / 23.5oz
	Dimensions	192 x 75 x 52mm / 7.5 x 3.0 x 1.9inches	192 x 79 x 55mm / 7.5 x 3.1 x 2.2inches	200 x 79 x 52mm / 7.9 x 3.0 x 2.0inches	200 x 79 x 54mm / 7.9 x 3.1 x 2.1inches
	Micro SD card	32 ~128 (U1/C10) GB	32 ~128 (U1/C10) GB	32 ~128 (U1/C10) GB	32 ~128 (U1/C10) GB
	Water Proof	IP67	IP67	IP67	IP67
	WIFI / APP	Yes	Yes	Yes	Yes
	IR Wavelength	Vscl:850/940nm	Vscl:850/940nm	Vscl:850/940nm	Vscl:850/940nm
	Infrared	Class 3R Eye Safe	Class 3R Eye Safe	Class 3R Eye Safe	Class 3R Eye Safe
	Operating Temperature	-20~50 C / -4~122F	-20~50 C / -4~122F	-20~50 C / -4~122F	-20~50 C / -4~122F
	Bluetooth	-	Yes	-	Yes
Max LRF Range	-	5~1000M / 5~1100yard	-	5~1000M / 5~1100yard	

■ Features

- Built-in Ballistic Calculation and precision LASER Rangefinder(LRF models only)
- High Resolution Imaging
- Video Recording in 1920 x 1080 60 Hz
- Micro-OLED HD Display, 60 Hz
- One Shot Zero
- 3-Axis Gyroscope
- Picture-in-Picture Function
- Full-color at Dawn and Dusk
- Ballistic Calculation APP
- Wireless Firmware Updating Via App
- Customized Ballistic Table

■ Controls & Buttons LRF

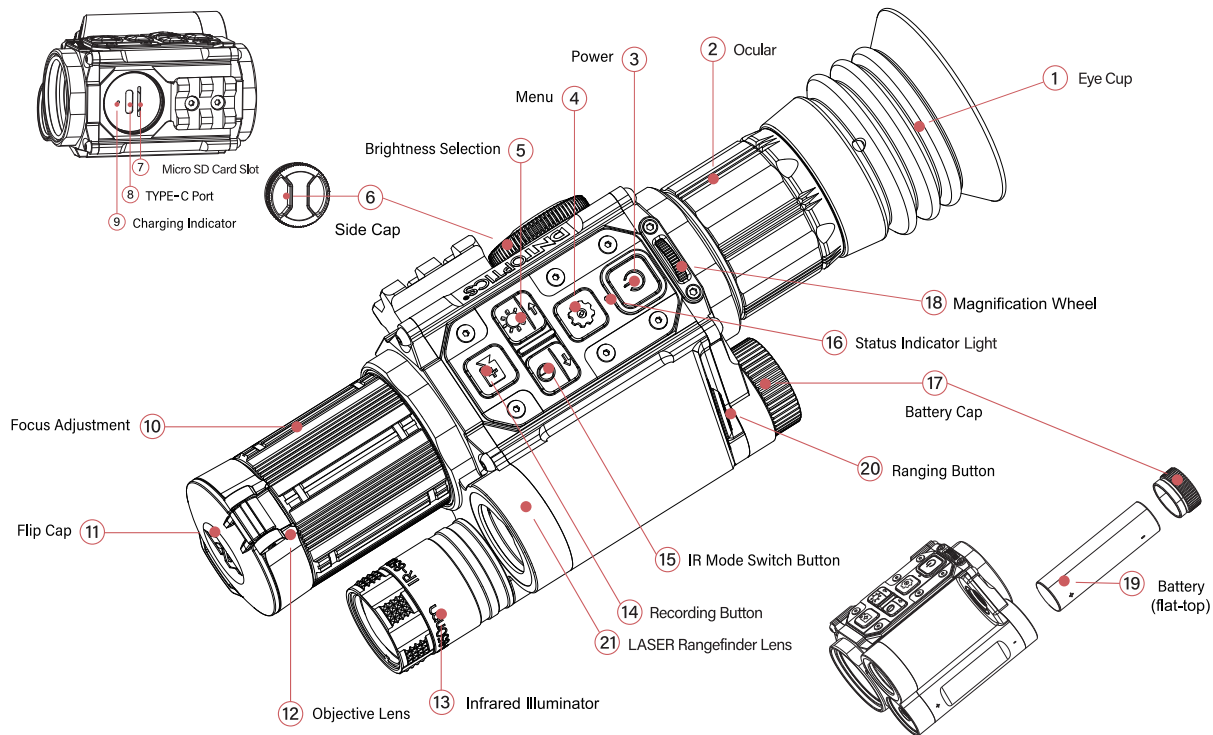

■ Controls & Buttons

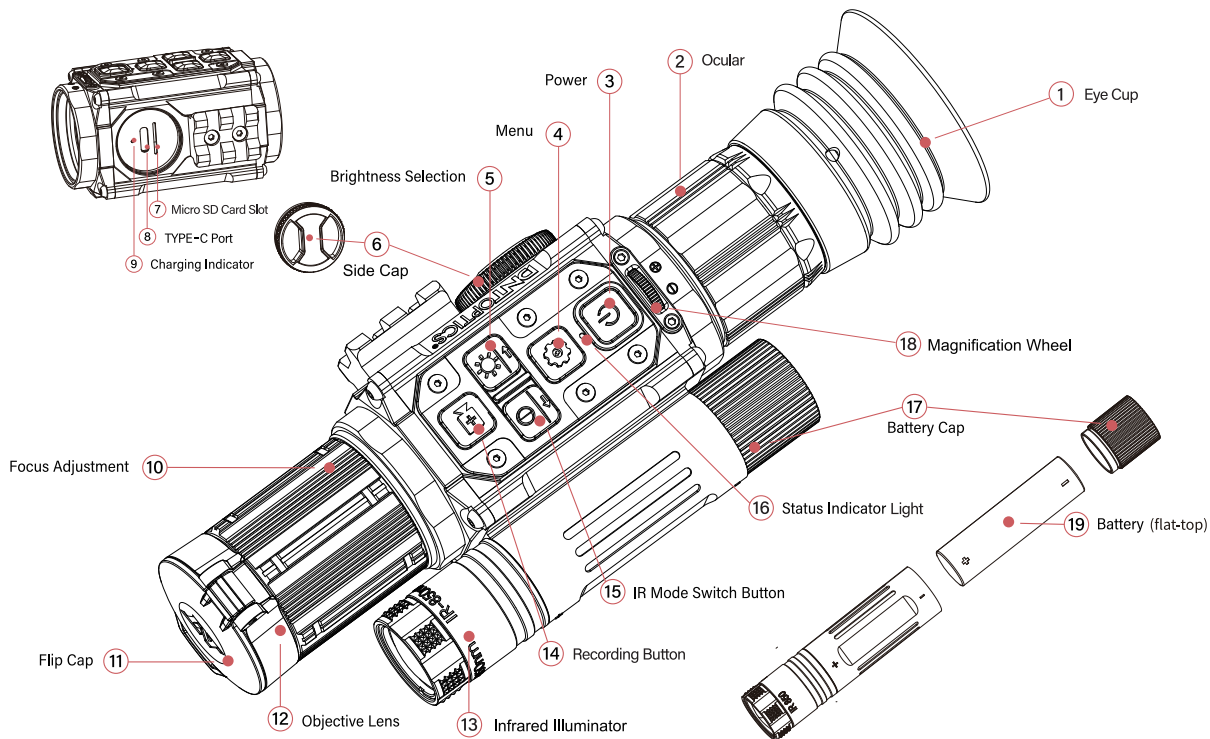

■ Main Functions

Power Supply

This device is powered by an external 18650 battery (flat-top) with up to 8 hours of operation time (when the IR Illuminator is turned off). The battery can be charged with a battery charger when removed or with a Type-C power source plugged into the Zulus device. Please ensure battery is fully charged before use.

Note: Please ensure proper 18650 Flat Top Batteries are used. Damage by improper batteries may void warranty.

Installing the 18650 Battery (flat-top)

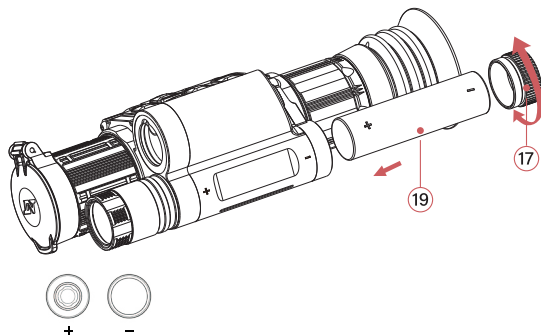

1. Twist counter clockwise to remove the Battery Cap (17)

2. Insert 18650 battery (19) positive side "+" first

3. Twist Battery Cap clockwise to install until fully tightened.

TYPE-C Charging

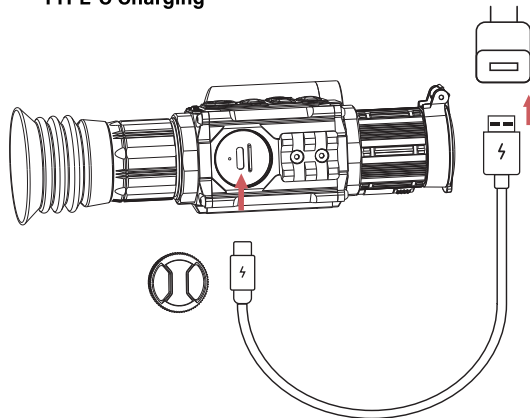

Note: To use TYPE-C cable for charging, a power adapter (5V2A) is needed.

Main Functions

Micro SD Card Slot

Before initial use of Micro SD Card(32Gb-128Gb), you need to insert it into scope and navigate through Menu find to **System Settings - Formatting**, confirm **Formatting** to erase the card(make sure there's no valuable data before formatting Micro SD Card)

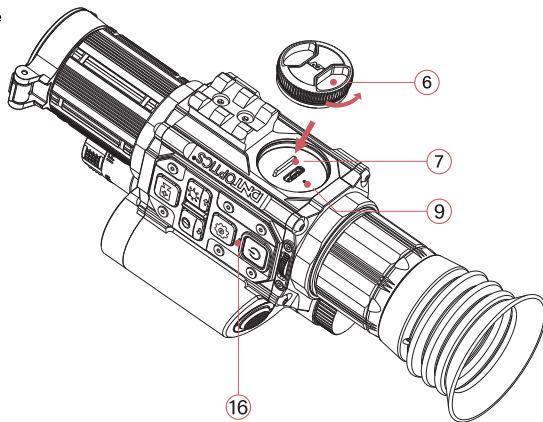

Open side cap ⑥ and insert Micro SD Card into the slot ⑦

Note: Micro SD Card is directional

Status Indicator Light

Status Indicator Light	Color	On	Flash
Charging ⑨	●	Charging	--
Status ⑯	●	On	--
	●	Standby	Updating: Yellow light flashing

Main Functions LRF models only

IR Illuminator Installation and Focus Adjustment

The LRF models are equipped with a removable IR Illuminator, and installed by default from the factory. You can remove/install it by following the instructions.

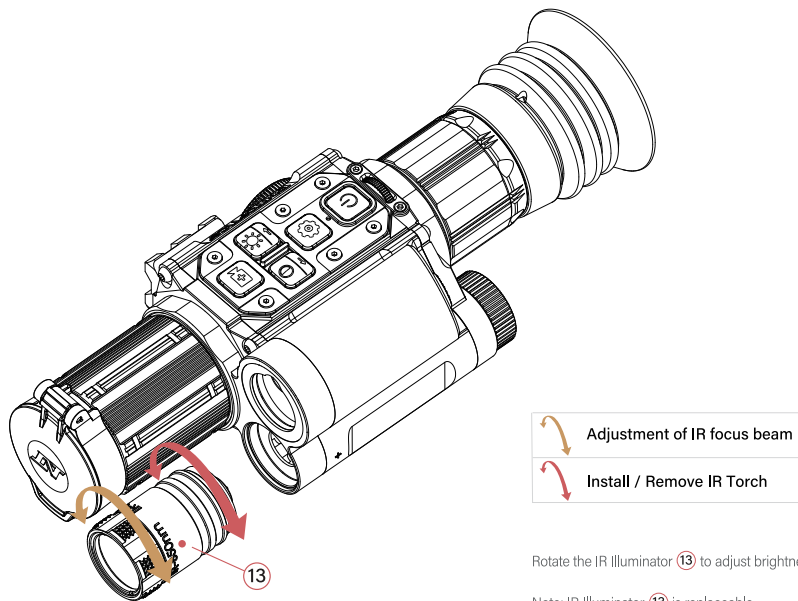





Rotate the IR Illuminator 13 to adjust brightness. Optimal focus enables maximum detection range.

Note: IR Illuminator 13 is replaceable.

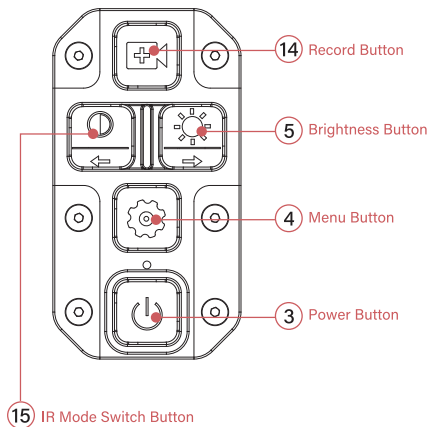
Main Functions

Control Description





Button	Status	Short press	Long press
 3	Off	--	On
	On	Standby	Off
	Standby	Wake-up	-
	Zeroing Interface	Freeze/Continue	-
 4	On	Reticle Color Switch	Menu Interface
	Main Menu	Exit Settings	-
	Sub Menu	Exit Sub Menu	-
	Zeroing Interface	Reticle X/Y Value Adjust Once	Reticle X/Y Value Continuous Adjust
 15	On	--	Black/White Mode
	Black/White Mode	IR Brightness Adjust	Color Mode
	Main Menu	Move Cursor to the left	-
	Sub Menu	Move Cursor to the left	Save and Exit
	Zeroing Interface	Move Cursor to the left	Save and Exit
 5	On	Screen Brightness Adjust	Wi-Fi On/Off
	Main Menu	Move Cursor to the Right	-
	Sub Menu	Move Cursor to the Right	Exit Current Setting
	Zeroing Interface	Move Cursor to the Right	Exit Current Setting
 14	On	Start Recording/Pause/Resume	Start/End Recording
	Main Menu	Confirm the Selection	-
	Zeroing Interface	Reticle X/Y Value Adjust Once	Reticle X/Y Value Continuous Adjust

■ Main Functions

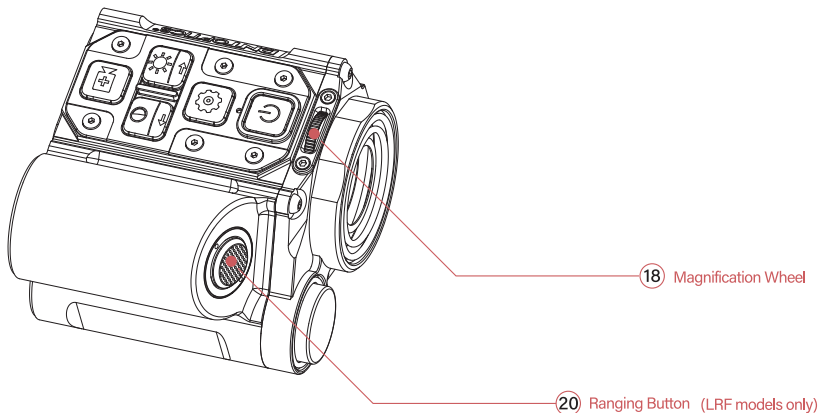
Control Description



Button	Status	Short press	Long press	Rotation
 18	On	–	--	Spin right to increase magnification and Spin left to decrease magnification
	Zeroing Interface	–	--	Spin right to increase magnification and Spin left to decrease magnification
 20	Not Connected to App	(Without uploaded ballistic table) Show / Hide LRF Icon and Distances	Turn Off Ranging	–
	Not Connected to App	(With uploaded ballistic table) Show / Hide ballistic calculation result	Turn Off Ranging	–
	Connected to App	Ranging and Ballistic Calculation	Turn Off Ranging	–

Main Functions

Interface Description

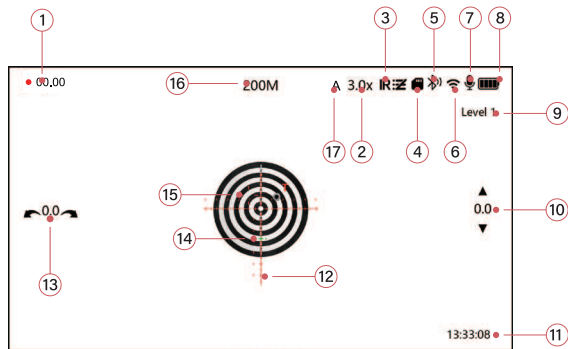

- ① Recording Indicator: The recording timer indicates that the device is currently recording; The displayed number on the timer represents the duration of the recorded video.
- ② Current Magnification (E.g. 3.0x).
- ③ The displayed Icon indicates if the device is in Black and White or Color Mode.

Vscel: 850/940nm		Black and white mode; Illuminator off
		Brightness Level 1
		Brightness Level 2
		Brightness Level 3
		Brightness Level 4
		Brightness Level 5
		Black and white mode; Brightness will be adjusted automatically

LED: 850nm		Black and white mode; Illuminator off
		Brightness Level 1
		Brightness Level 2
		Brightness Level 3
		Black and white mode; Brightness will be adjusted automatically

- ④ Micro SD Card (Card icon appears when installed, The recording won't work without the SD card).
- ⑤ Bluetooth (Bluetooth on, Bluetooth off, Bluetooth Connected).
- ⑥ WiFi (Wi-Fi On, Wi-Fi Off).
- ⑦ Microphone, Indicates whether sound is be included when recording.
 Microphone On Microphone Off.
- ⑧ Battery Status

Icon	Status	Battery Status
	1 bar	10% ~ 20%
	2 bars	20% ~ 50%
	3 bars	50% ~ 80%
	4 bars	80% ~ 100%
	Charging	Connect Type C to charge

- ⑨ Level 1: Current Display Brightness (Level 1-6 with Increasing Brightness).
- ⑩ Gyroscope Vertical Drift. ⑭ Point of Impact.
- ⑪ Current Time. ⑮ Ranging Icon.
- ⑫ Reticle. ⑯ Ranging Distance.
- ⑬ Gyroscope Horizontal Drift. ⑰ The currently implemented zero profile name (from A-E)

Note: Distance read(include ranging icon) and Bluetooth functions are LRF models only.

■ Main Functions

Menu List

Long press **Menu Button** (4) for 2 seconds to enter Menu list; There are 15 selections in total; Use **IR Mode Switch Button** (15) and **Brightness Button** (5) to navigate through menu options; Short press the **Recording Button** (14) to confirm selection.



Long Press 2s

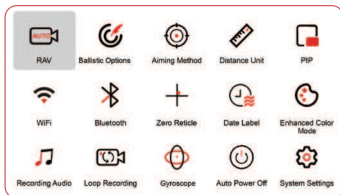

Menu Navigation Instruction

(Short press)

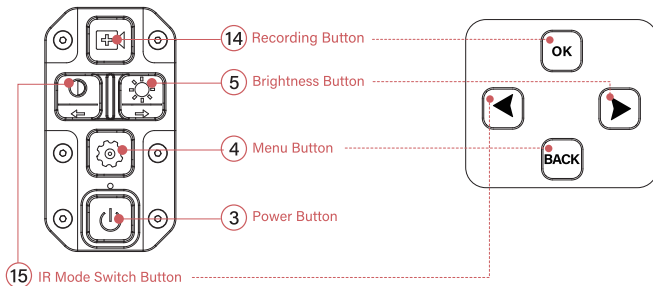

Menu Navigation Instruction

(Long press)



Main Functions LRF models only

IR Illuminator Settings

Ensure the correct IR illuminator setting is selected for the IR light in use (IR_L 850nm / IR_V 850nm)

- Check the IR Illuminator Type of your device, which is printed at the body of it.
- Select the correct IR Type: Long press **Menu Button** (4) and navigate to **IR Torch Types**, Short press **Recording Button** (14) to the sub-menu and select the **IR Torch Types** that currently mounted on the scope.

Caution: The LRF Zulus equipped IR_V 850nm Illuminator by default, Changing to IR_L 850nm needs to set the "IR Torch Types" accordingly, Wrong settings of IR Torch Types might cause damage to the IR Torch.

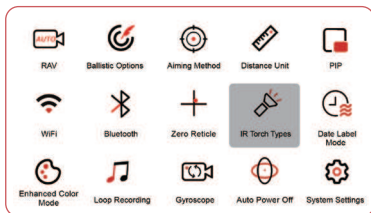

(menu)

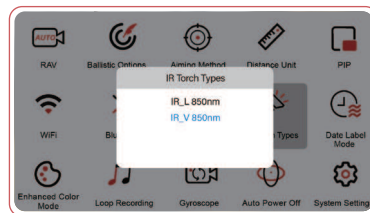

(press to Confirm)









Note: IR_V 850nm stands for 850nm wavelength VCSEL (LASER) type IR torch







IR_L 850nm stands for 850nm wavelength LED type IR torch

■ Main Functions

Menu List

Long press **Menu Button** (4) for 2 seconds to enter Menu list; There are 15 selections in total; Use **IR Mode Switch Button** (15) and **Brightness Button** (5) to navigate through menu options; Short press the **Recording Button** (14) to confirm selection.

Icon	Description
	[RAV] Recoil Activated Recording
	[Ballistic Options] Ballistics Calculation
	[Aiming Method] Select "Dial-in" or "Holdover" to Target
	[Distance Unit] Select the Unit of Distance
	[PIP] Picture-in-Picture option
	[Wi-Fi] Wi-Fi On/Off
	[Bluetooth] Bluetooth On/Off
	[Zero Reticle] Reticle Zeroing
	[Date Label] Enable Time Stamp for Recordings

Icon	Description
	[Enhanced Color Mode] Select Mode: Enhanced Color / Natural Color
	[Recording Audio] Record Audio On/Off
	[Loop Recording] Set Video Duration : 1 Minute, 3 Minutes, 5 Minutes or OFF (default 10 Minutes)
	[Gyroscope] Gyroscope Calibration
	[IR Torch Types] IR_L 850nm(LED), IR_V850nm(VCSEL)
	[Auto Power Off] In Auto Power Off Mode, The Device will Automatically Power OFF after 10, 20 or 30 Minutes of Inactivity
	[System Settings] Adjust time and Date, Check Version No, Change Language, SD Card Formatting, Restore Factory Settings <small>(Note : Formatting the SD card will erase all files stored on the card)</small>

■ Main Functions

Main Function Description

Reticle Zeroing

Long press the **Menu Button** (4) for 2 seconds to enter Settings. Press the **Brightness Button** (5) to move cursor to Zero Reticle then press **Recording Button** (14) to select Reticle Setting.



- Short press **Brightness Button** (5) to move cursor to the right; Short press the **IR Mode Switch Button** (15) to move cursor to the left;
- Short press **Recording Button** (14) to increase current value by 1; Long press (without release) to continuously increase the current value within the allowed range. Short press the **Menu Button** (4) to decrease current value by 1; Long press (without release) to continuously decrease the current value within the allowed range;
- Long press **IR Mode Switch Button** (15) for 2 seconds to save and exit Reticle Zeroing; Long press **Brightness Button** (5) to exit without saving;
- Short press **Power Button** (3) to freeze/reactivate current image.

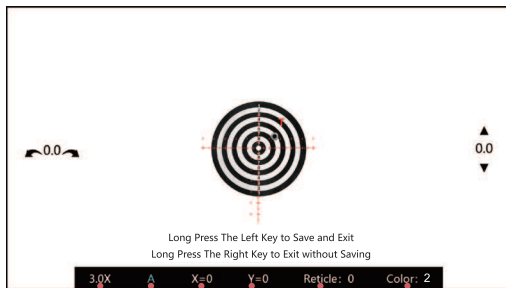

1

2

3

4

5

6

- 1 3.0x: Current objective magnification; adjustable with Magnification Wheel (18)
- 2 A: Current zero profile, up to 5 (A-E) Profiles for zero settings
- 3 X=0: Current coordinate point of reticle in horizontal direction
- 4 Y=0: Current coordinate point of reticle in vertical direction
- 5 Reticle: 5 reticle options (Include reticle off)
- 6 Color: 5 color options white(0) , green(1) , red(2) , yellow(3) , black(4)

■ Main Functions

Reticle Zeroing Example

Place the target at 50 meters, adjust the focus to ensure the **Objective Lens** (12) provides a sharp image of the target; On the target, select a central point of aim and observe for the point of impact (T). Return the reticle to the original point of aim and short press the **Power Button** (3) to freeze the sight picture. Using **X** and **Y**, align the reticle with the point of impact. Long press **IR Mode Switch Button** (15) to save.

Note: Once the reticle has been changed (either moved or changed Shape or color), the magnification cannot be adjusted.



(Before Zeroing)



(After Zeroing)

■ Main Functions

Distance Measurement Function LRF models only

In the ballistic calculation menu, if you select "Off" or fail to connect to the mobile app, the LRF will only display distance.

- Short press the **Ranging Button** to turn on the distance measuring function. The Ranging Icon 15 and current target distance 16 will display on the screen (The LRF will continuously measure distances once turned on).
- Continue to short press or long press the **Ranging Button** for 1.5 seconds to turn off the distance measurement function. The Ranging Icon and current distance will not displayed on the screen.



(First short press Ranging Button)



(Long press Ranging Button for 1.5 seconds)

Main Functions

Ballistic Calculation - Ballistic Table LRF models only

- To upload/update a Ballistic Table on your Zulus, open Ballistic Calculation in the main menu and select "Ballistic Table Query" You must be connected to the mobile app.
- Click the Send Icon  to upload/update your Zulus Ballistic Table. Ballistic Calculations are performed using data extracted from the Ballistic Table uploaded through the mobile app.

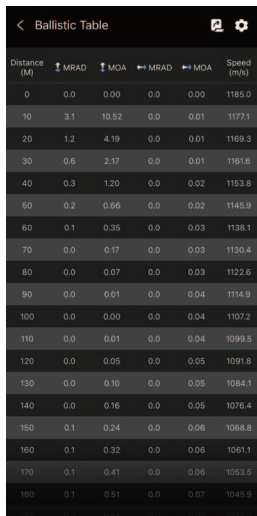

Distance (M)	MRAD	MOA	MRAD	MOA	Speed (m/s)
0	0.0	0.00	0.0	0.00	1185.0
10	3.1	10.52	0.0	0.01	1177.1
20	1.2	4.19	0.0	0.01	1169.3
30	0.6	2.17	0.0	0.01	1161.6
40	0.3	1.20	0.0	0.02	1153.8
50	0.2	0.66	0.0	0.02	1145.9
60	0.1	0.35	0.0	0.03	1138.1
70	0.0	0.17	0.0	0.03	1130.4
80	0.0	0.07	0.0	0.03	1122.6
90	0.0	0.01	0.0	0.04	1114.9
100	0.0	0.00	0.0	0.04	1107.2
110	0.0	0.01	0.0	0.04	1099.5
120	0.0	0.05	0.0	0.05	1091.8
130	0.0	0.10	0.0	0.05	1084.1
140	0.0	0.16	0.0	0.05	1076.4
150	0.1	0.24	0.0	0.06	1068.8
160	0.1	0.32	0.0	0.06	1061.1
170	0.1	0.41	0.0	0.06	1053.5
180	0.1	0.51	0.0	0.07	1045.9

(BC ballistic table interface)

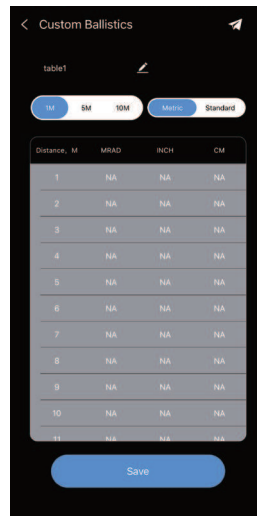

Distance, M	MRAD	INCH	CM
1	NA	NA	NA
2	NA	NA	NA
3	NA	NA	NA
4	NA	NA	NA
5	NA	NA	NA
6	NA	NA	NA
7	NA	NA	NA
8	NA	NA	NA
9	NA	NA	NA
10	NA	NA	NA
11	NA	NA	NA

(Customized ballistic table interface)

Main Functions

Built-in Ballistic Calculation **LRF models only**

Step 1 To switch between the Ballistic Table and the Ballistic Calculation, open "Ballistic Options" in the main menu. You can select different mode of ballistic calculation on the list by moving up and down with **IR Mode Switch Button** (15) and **Brightness Button**(right) (5)

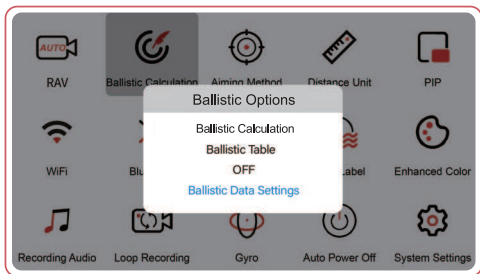

Step 3 Select Ballistic Calculation to utilize the data entered into the Ballistic Data Settings, and short press **Recording Button** (14) to confirm

Step 2 Select Ballistic Data Settings and enter the required information, as shown below. Long press **IR Mode Switch Button** (15) to save.

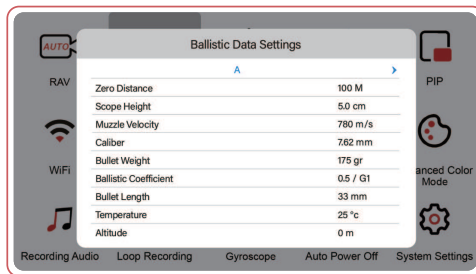

Store up to five customizable Ballistic Profiles (A to E).

Main Functions

Built-in Ballistic Calculation Setting Example **LRF models only**

Note: You can change the parameters via mobile APP

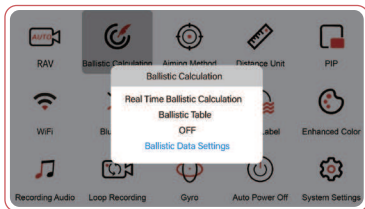

Enter the menu and select **Ballistic Calculation**, then enter the **Ballistic Data Settings**

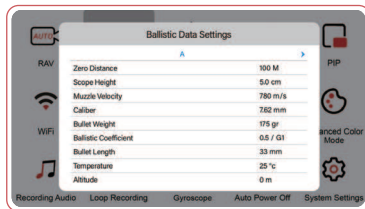

Choose Ballistic Profile, and enter with short press of **Recording Button**

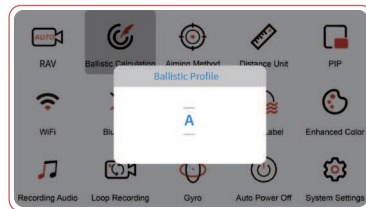

Short press **IR Mode Switch Button** or **Brightness Button** to select profile. Short press **Recording Button** to confirm profile, short press **Menu Button** to go back.



Short press **IR Mode Switch Button** or **Brightness Button** to highlight unit of measure or distance value. Short press **Recording Button** or **Menu Button** to change the highlighted. Long press **IR Mode Switch Button** to save.

Long press **IR Mode Switch Button** to Save & Exit each parameter setting, long press **Brightness Button** to exit without saving. After each parameter setting has been entered, the Zulus LRF is able to make ballistic calculations.

■ Main Functions

Aiming Method - Holdover LRF models only

Enter Menu Options, Aiming Point Method: Select "Holdover".

- Turn the LRF on by a short press of the **Ranging Button**. Ranging Icon 15 and distance will 16 appear without a holdover solution
- After the target has been ranged, a second short press of the **Ranging Button** will hide the ranging icon 15 and display the calculated point of aim 14 via holdover
- A third short press of the **Ranging Button** will hide the holdover solution while displaying the ranging Icon 15 and distance 16
- Long press the **Ranging Button** for 1.5 seconds to turn the LRF off. Ranging Icon 15 and distance 16 will disappear



(First short press Ranging Button)



(Second short press Ranging Button)



(Third short press Ranging Button)



(Long press Ranging Button for 1.5 seconds)

■ Main Functions

Aiming Method- Dial in **LRF models only**

Enter Menu Options, Aiming Method: Select "Dial in"

- Short press the **Ranging Button** to turn the LRF on. Ranging Icon (15) and distance (16) will display
- Second short press of the **Ranging Button** will hide the ranging Icon (15) while displaying distance (16) and moving the reticle to the calculated point of impact
- Third short press will turn off the dial in function and return the reticle to its original zero. Ranging Icon (15) and distance (16) will be displayed
- Long press the **Ranging Button** for 1.5 seconds to turn the LRF off. Ranging Icon (15) and distance (16) will disappear

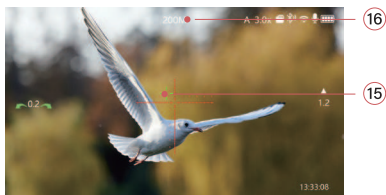

(First short press Ranging Button)

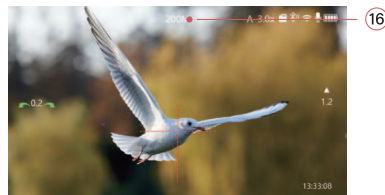

(Second short press Ranging Button)



(Third short press Ranging Button)



(Long press Ranging Button for 1.5 seconds)

■ Main Functions

Image Quality Enhancement Function

Choose between natural color images and enhanced color images.



Natural Mode: this is more natural color (similar to human eyes)



Color Enhanced Mode: Image with enhanced color

APP Connections

Download the "DNT" App from the App store.

For Android devices, please go to Google Play Store, For iOS devices, please go to Apple Store
Search for "DNT" to download the App.

Connect scope to the APP

- Step 1** Enable Wi-Fi on both your scope and mobile device.
- Step 2** Enter the DNT optics APP, and tap on Add Device, your mobile device will display local network, find the scope Wi-Fi name and enter password (12345678), return to the App to access the optic.
- Step 3** Use DNT Optics APP to manage your devices and settings



Figure (1)

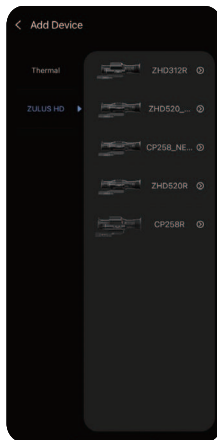

Figure (2)

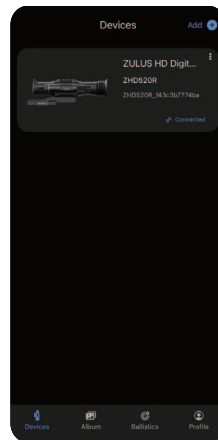

Figure (3)

■ APP Connections

Reticle Zeroing on App

Tap the icon  in the app. While in zeroing mode, press the **Power Button**  on the scope to freeze current sight picture.

With the sight picture frozen, use your finger to drag the reticle from the point of aim to the point of impact on your app.

Make precision adjustments using the up and down arrows. Once the reticle is aligned with the center of the point of impact, click "OK" to save zero.

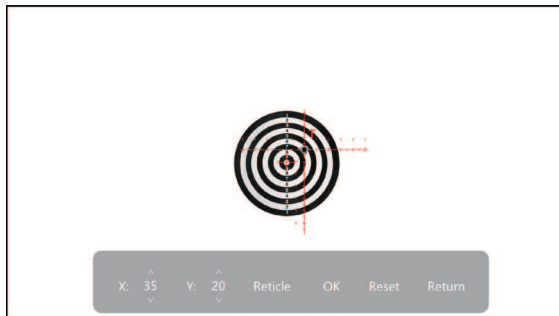
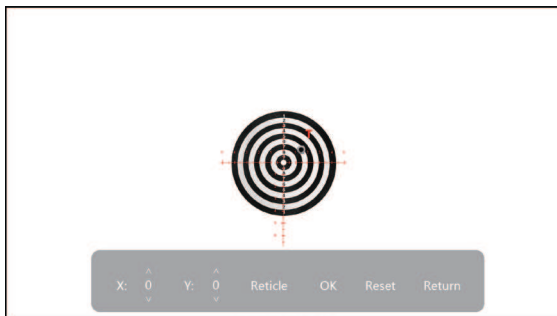

■ Firmware Updates

Using the "Firmware Update" feature on the App to perform online OTA/Wireless Updates.

■ FCC WARNING

This device complies with part 15 of the FCC Rules. Operation is subject to the following two conditions: (1) this device may not cause harmful interference, and (2) this device must accept any interference received, including interference that may cause undesired operation.

Any changes or modifications not expressly approved by the party responsible for compliance could void the user's authority to operate the equipment.

NOTE: This equipment has been tested and found to comply with the limits for a Class B digital device, pursuant to Part 15 of the FCC Rules. These limits are designed to provide reasonable protection against harmful interference in a residential installation. This equipment generates, uses and can radiate radio frequency energy and, if not installed and used in accordance with the instructions, may cause harmful interference to radio communications. However, there is no guarantee that interference will not occur in a particular installation.

If this equipment does cause harmful interference to radio or television reception, which can be determined by turning the equipment off and on, the user is encouraged to try to correct the interference by one or more of the following measures:

- Reorient or relocate the receiving antenna.
- Increase the separation between the equipment and receiver.
- Connect the equipment into an outlet on a circuit different from that to which the receiver is connected.
- Consult the dealer or an experienced radio/TV technician for help. The device has been evaluated to meet general RF exposure requirement. The device can be used in portable exposure condition without restriction.



ZULUS SERIES	LASER Rangefinder	Built-in Ballistic Calculation
ZHD 3-12x	-	-
ZHD 3-12x LRF	Y	Y
ZHD 5-20x	-	-
ZHD 5-20x LRF	Y	Y

www.dntoptics.com